



LAPRO SCOPY & ENDO SCOPY

Catalogue





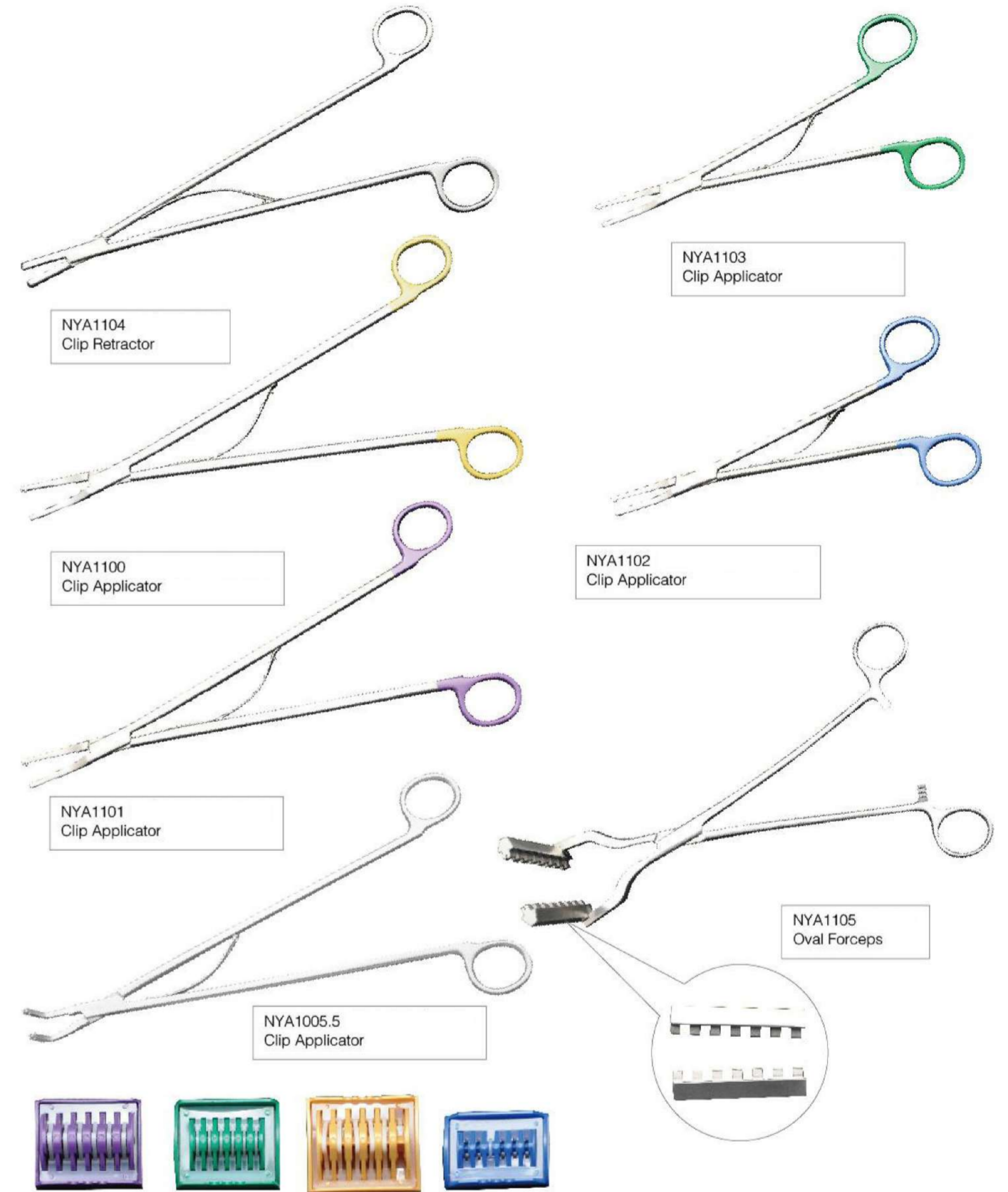
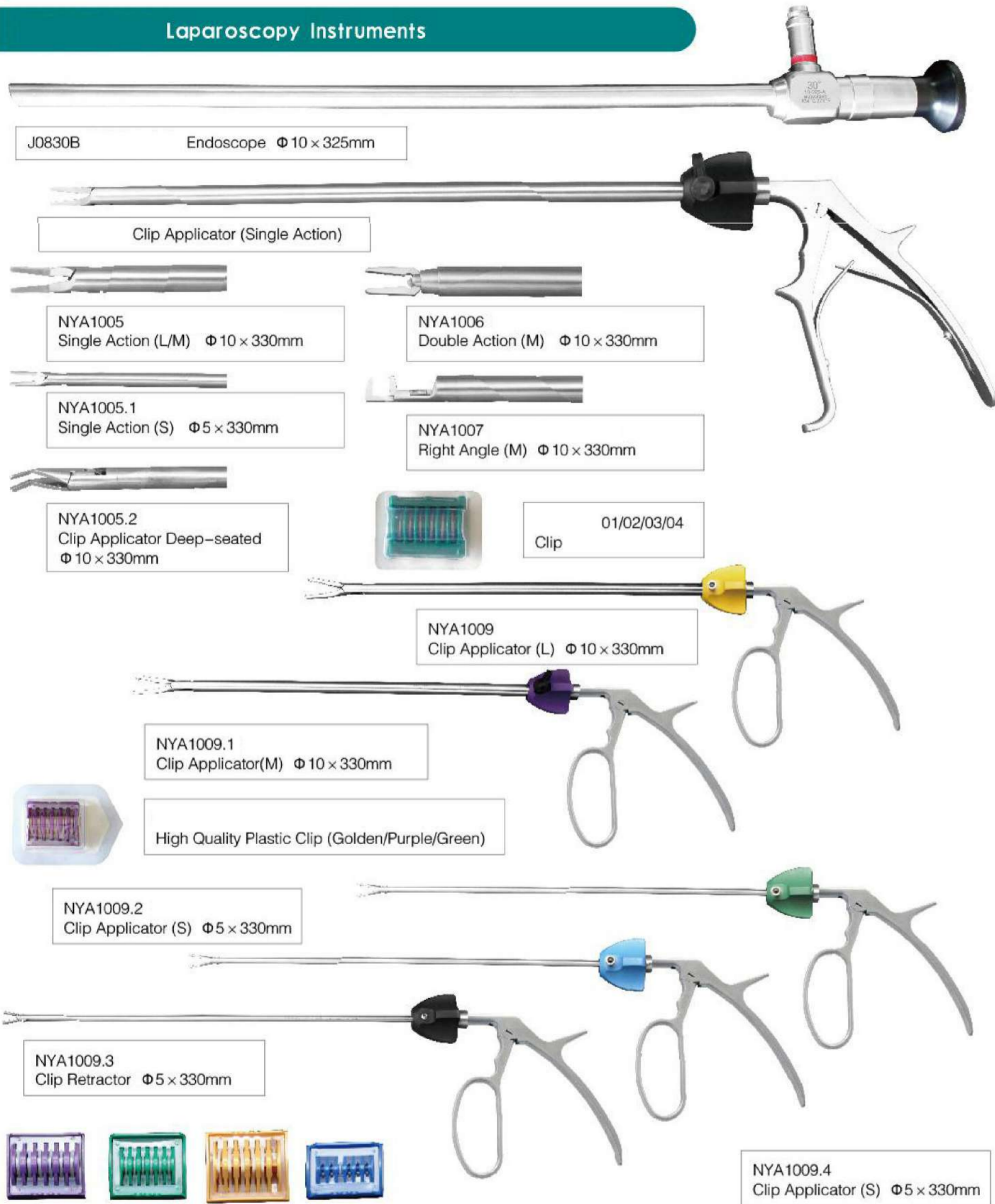



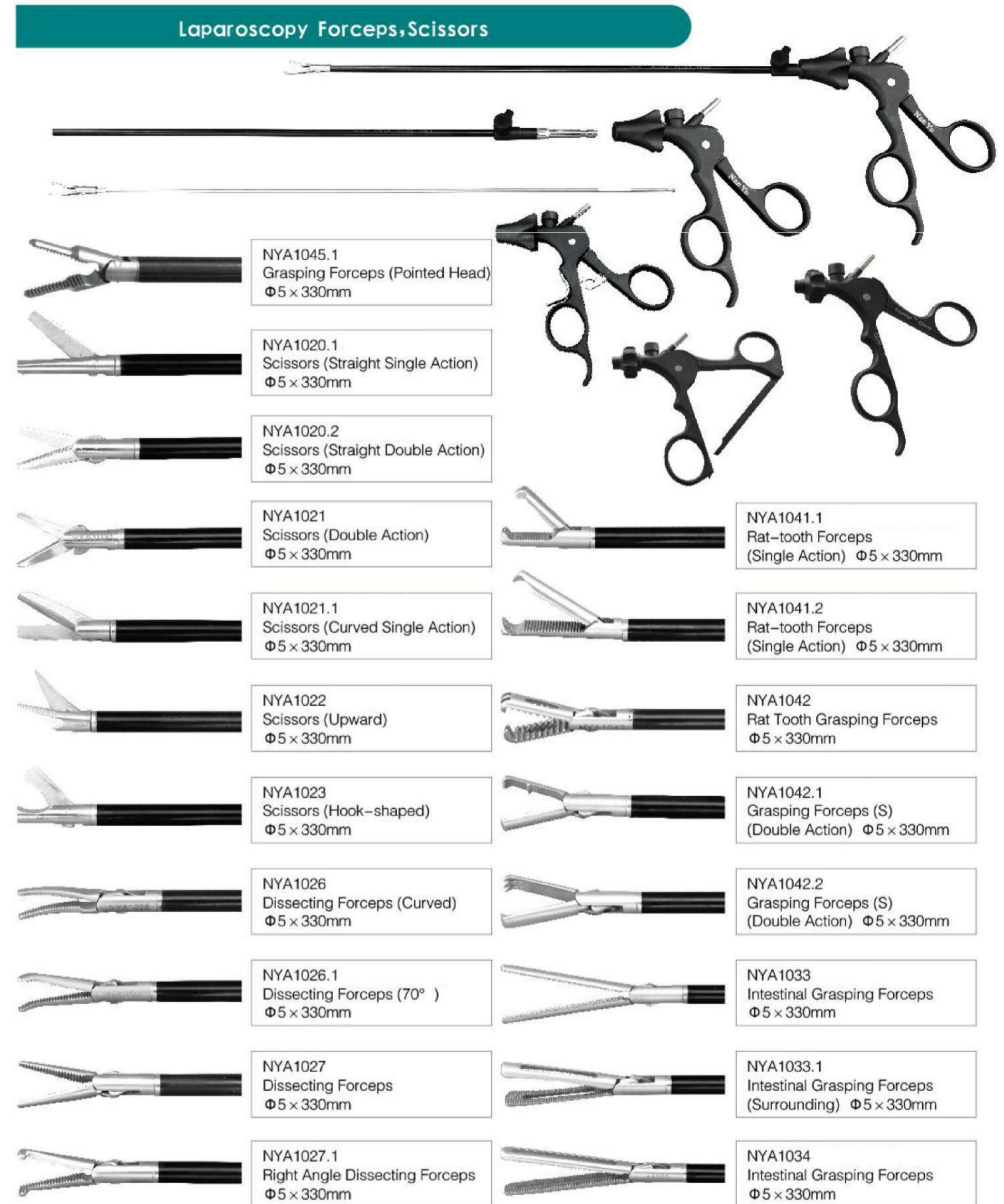
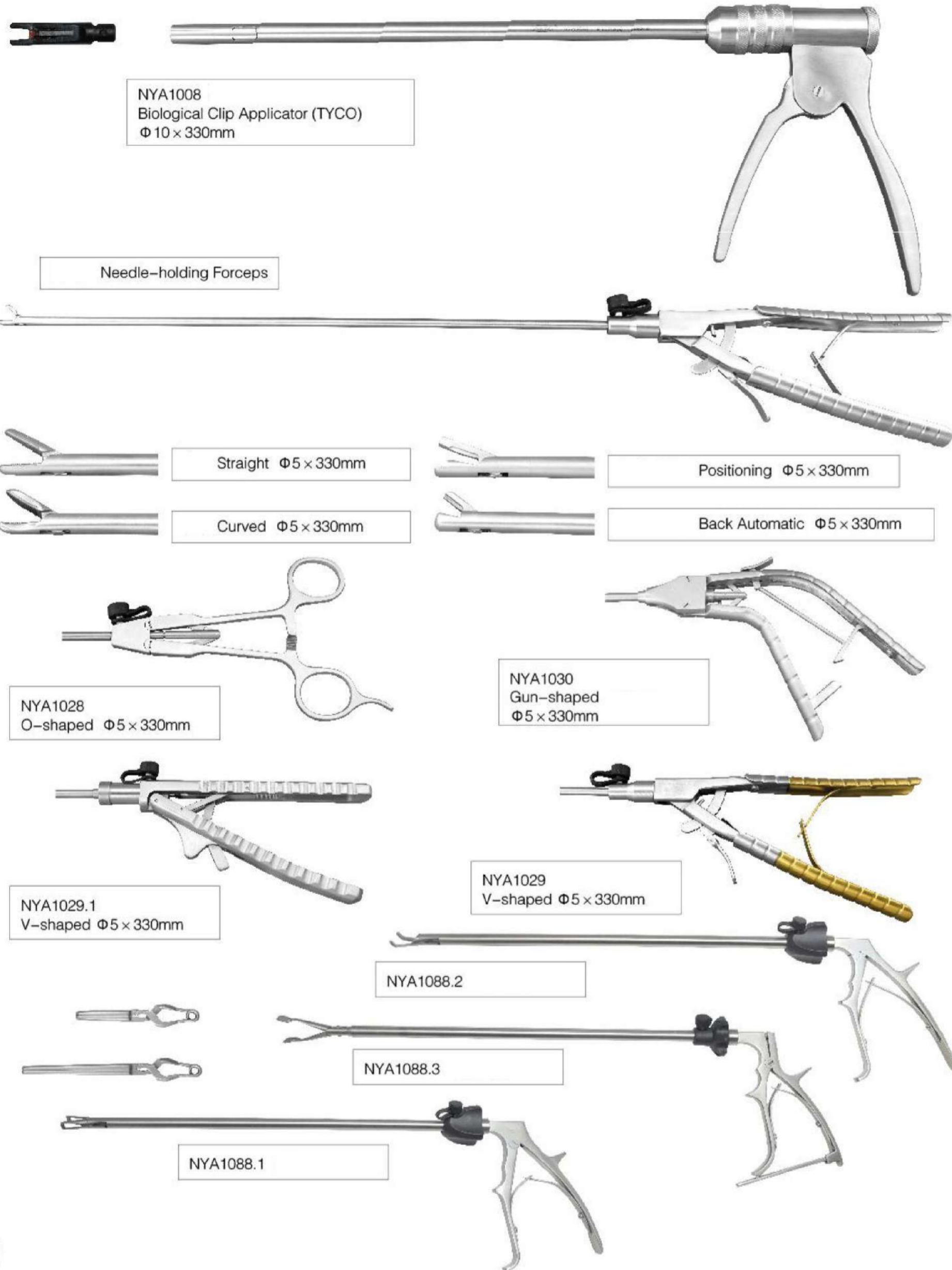





















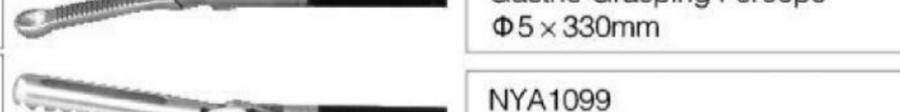

Laparoscopy Instruments











Laparoscopy Forceps, Scissors



	NYA1035 Duck Mouth Grasping Forceps Φ5 × 330mm		NYA1056 ///// Φ5 × 330mm
	NYA1036 Atraumatic Grasping Forceps Φ5 × 330mm		NYA1057 Grasping Forceps (3-holes) Φ5 × 330mm
	NYA1037 Atraumatic Grasping Forceps Φ5 × 330mm		NYA1064 Fan Retractor Φ5 × 330mm
	NYA1038 Heavy Grasping Forceps Φ5 × 330mm		NYA1066 Tying Forceps (A) Φ5 × 330mm
	NYA1039 Grasping Forceps (Backward Tooth) Φ5 × 330mm		NYA1067 Tying Forceps (B) Φ5 × 330mm
	NYA1040 Fixing Forceps Φ5 × 330mm		NYA1086 V-shaped Grasping Forceps Φ5 × 330mm
	NYA1044 Blunt Head Grasping Forceps Φ5 × 330mm		NYA1061.1 Gastric Grasping Forceps Φ5 × 330mm
	NYA1045 Grasping Forceps (Pointed Head) Φ5 × 330mm		NYA1061.2 Gastric Grasping Forceps Φ5 × 330mm
	NYA1047 Biopsy Forceps Φ5 × 330mm		NYA1061.3 Gastric Grasping Forceps (Curved) Φ5 × 330mm
	NYA1047.1 Canine Biopsy Forceps Φ5 × 330mm		NYA1062 Gastric Grasping Forceps Φ5 × 330mm
	NYA1048 Appendix Grasping Forceps Φ5 × 330mm		NYA1099 Atraumatic Grasping Forceps (Big-tooth) Φ5 × 330mm
	NYA1050 Gallbladder Grasping Forceps Φ5 × 330mm		NYA1148 Oval Forceps (S) Φ5 × 330mm
	NYA1051 Biting Forceps Φ5 × 330mm		NYA1148.1 Oval Forceps (M) Φ5 × 330mm
	NYA1052 Oviduct Grasping Forceps Φ5 × 330mm		NYA1148.2 Oval Forceps (L) Φ5 × 330mm
	NYA1053 Mesentery Grasping Forceps Φ5 × 330mm		
	NYA1054 Forceps with Tooth Φ5 × 330mm		
	NYA1055 Grasping Forceps Φ5 × 330mm		

Bipolar Coagulation Forceps

	NYA1016.3 Bipolar Dissecting Forceps	
	NYA1016.3	Φ5 × 330mm
	NYA1016.4	Straight Φ5 × 330mm
	NYA1106 Bipolar Cord	
	NYA1016.2 Bipolar Coagulation Forceps	
	NYA1016	Straight Φ5 × 330mm
	NYA1016.1	Circular Φ5 × 330mm
	NYA1016.2	Curved Φ5 × 330mm
	NYA1106 Bipolar Cord	

Electric Coagulator

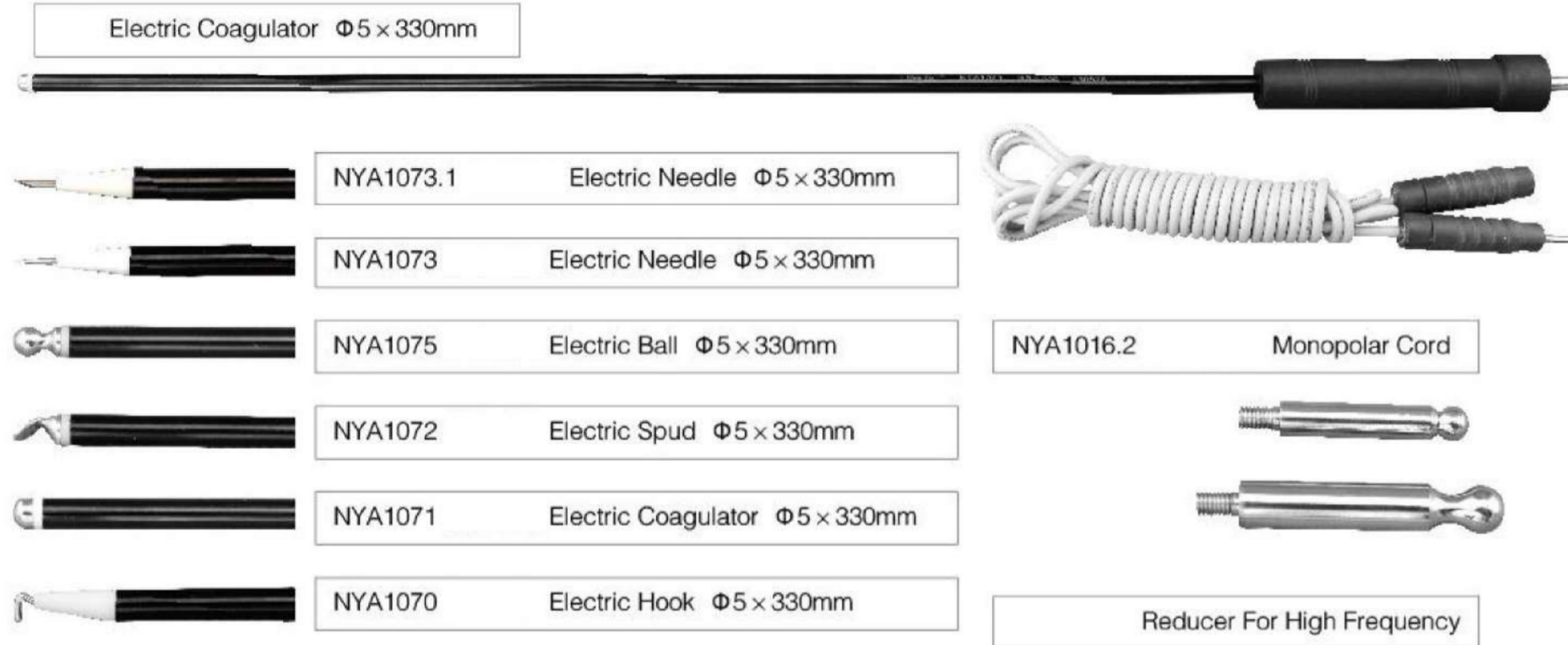

Electric Coagulator with Suction



Hernia Instrument



Irrigation

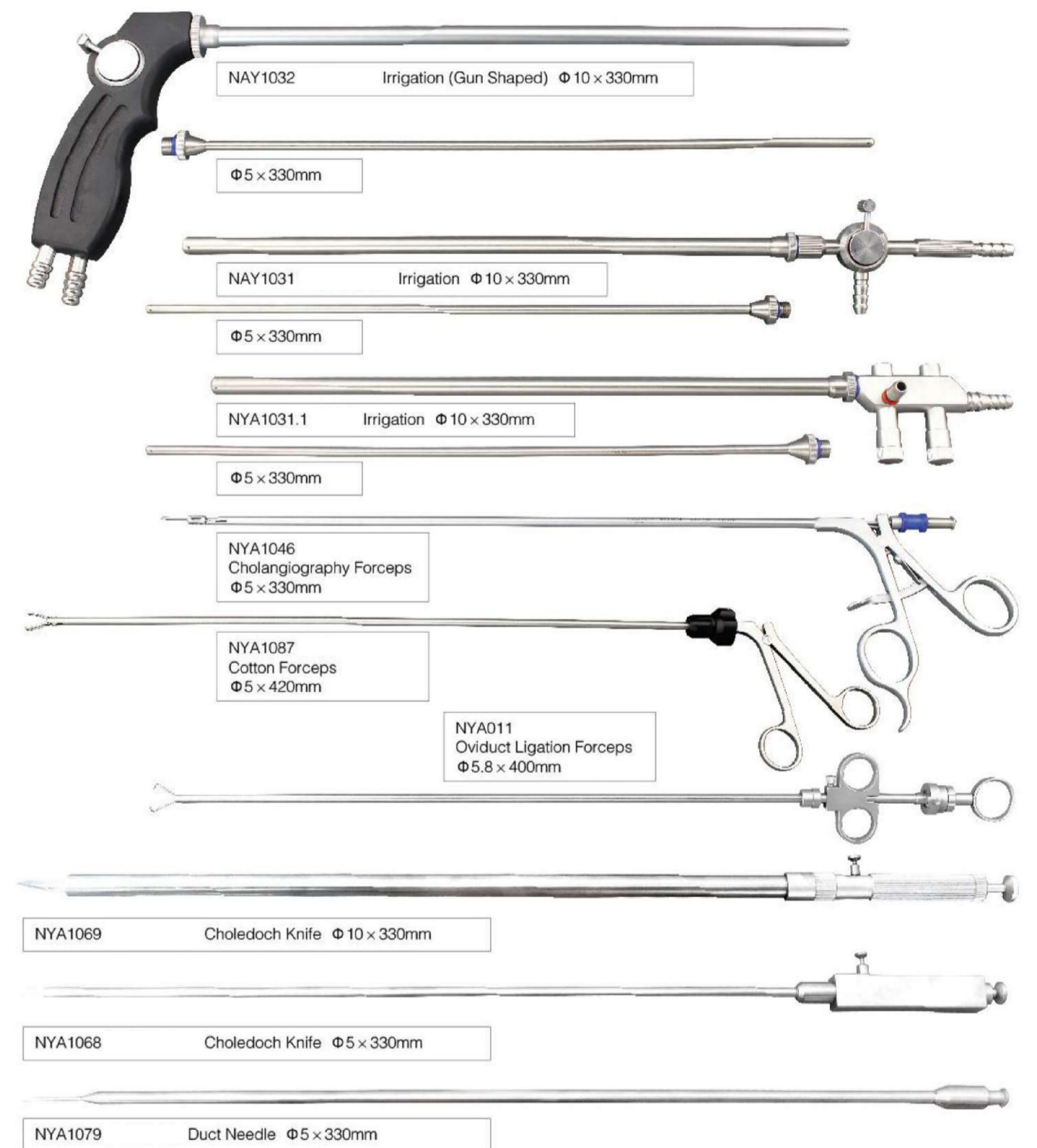

10mm Laparoscopy Instrument

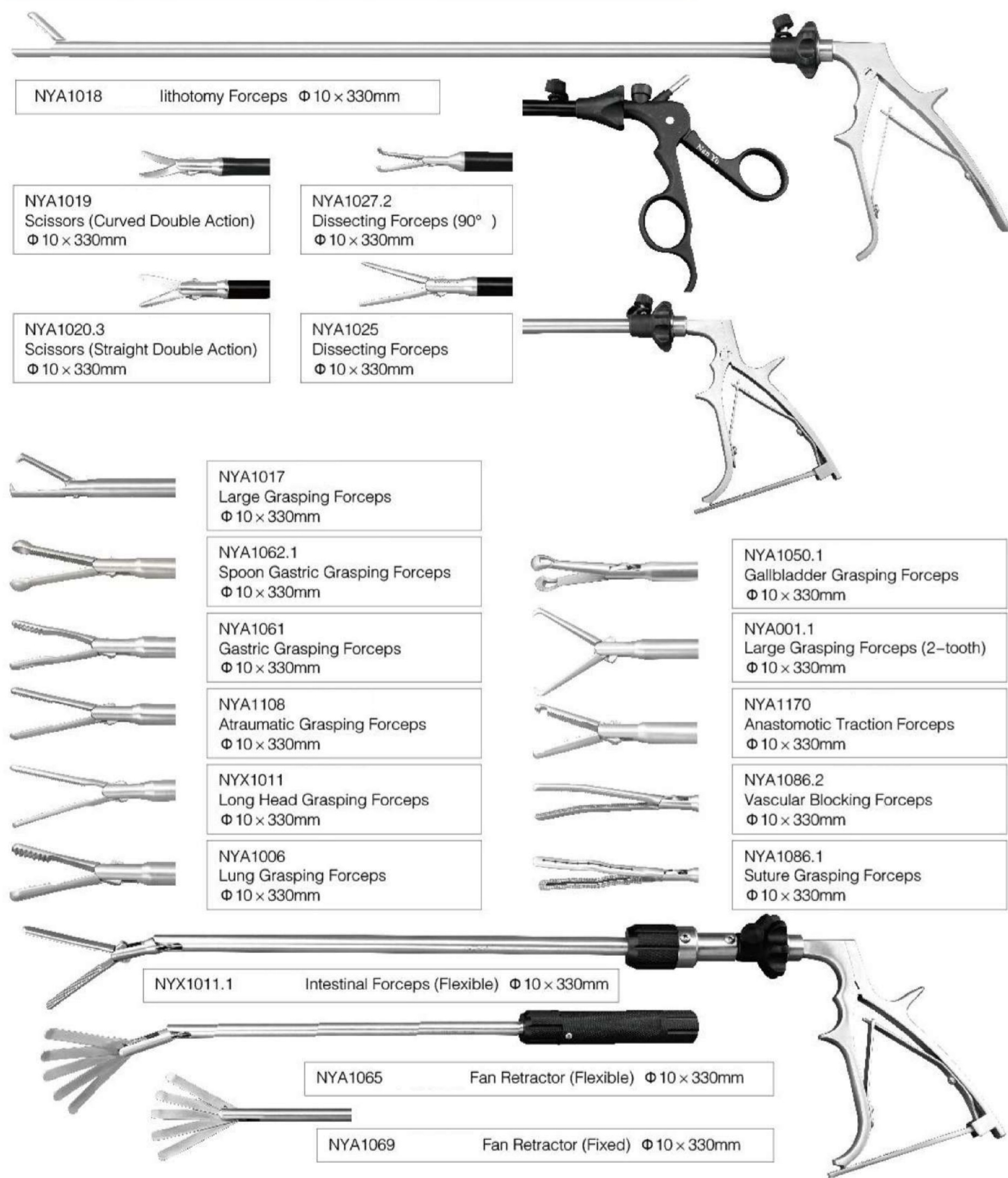

Trocar

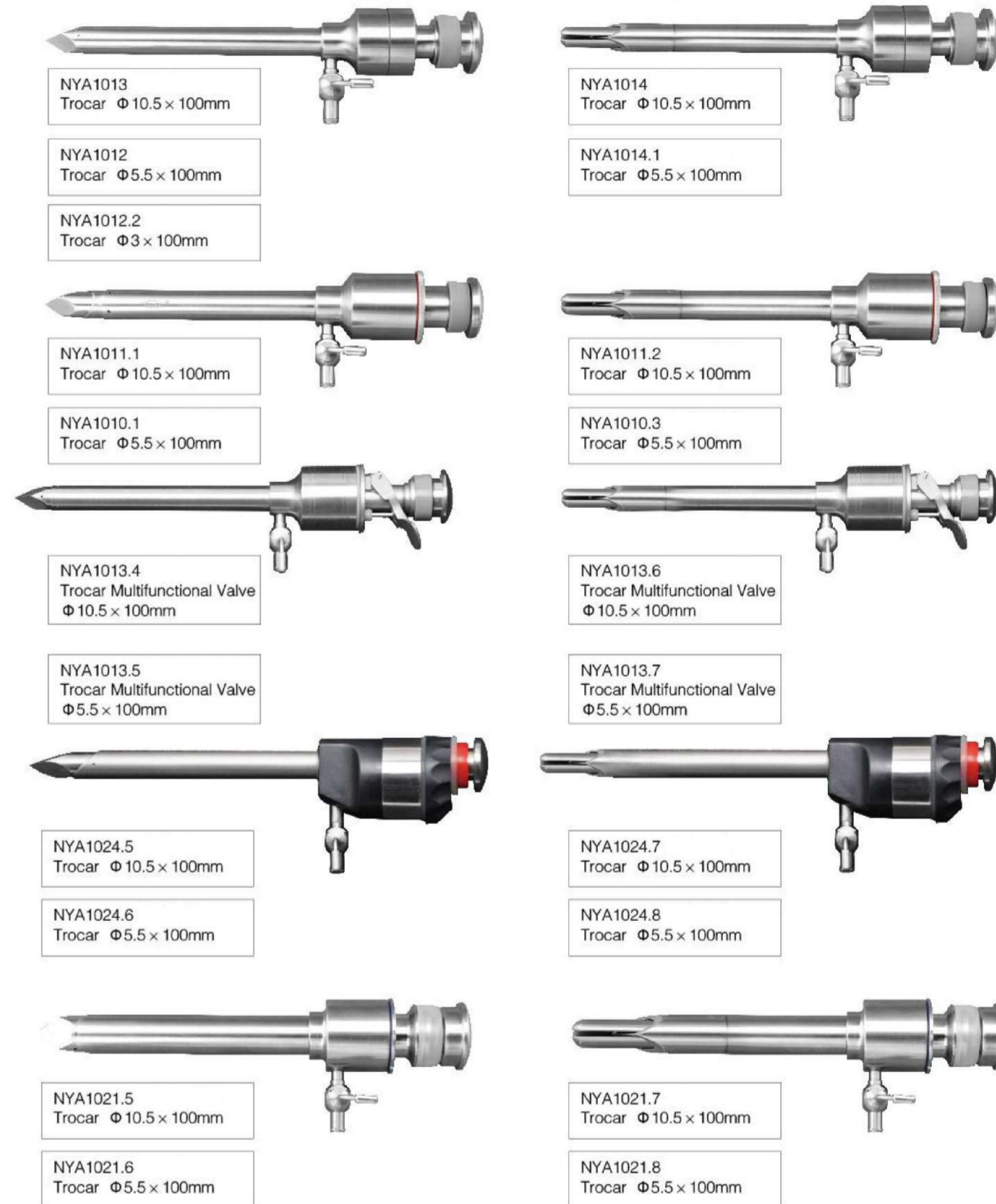

Thyroid Instruments

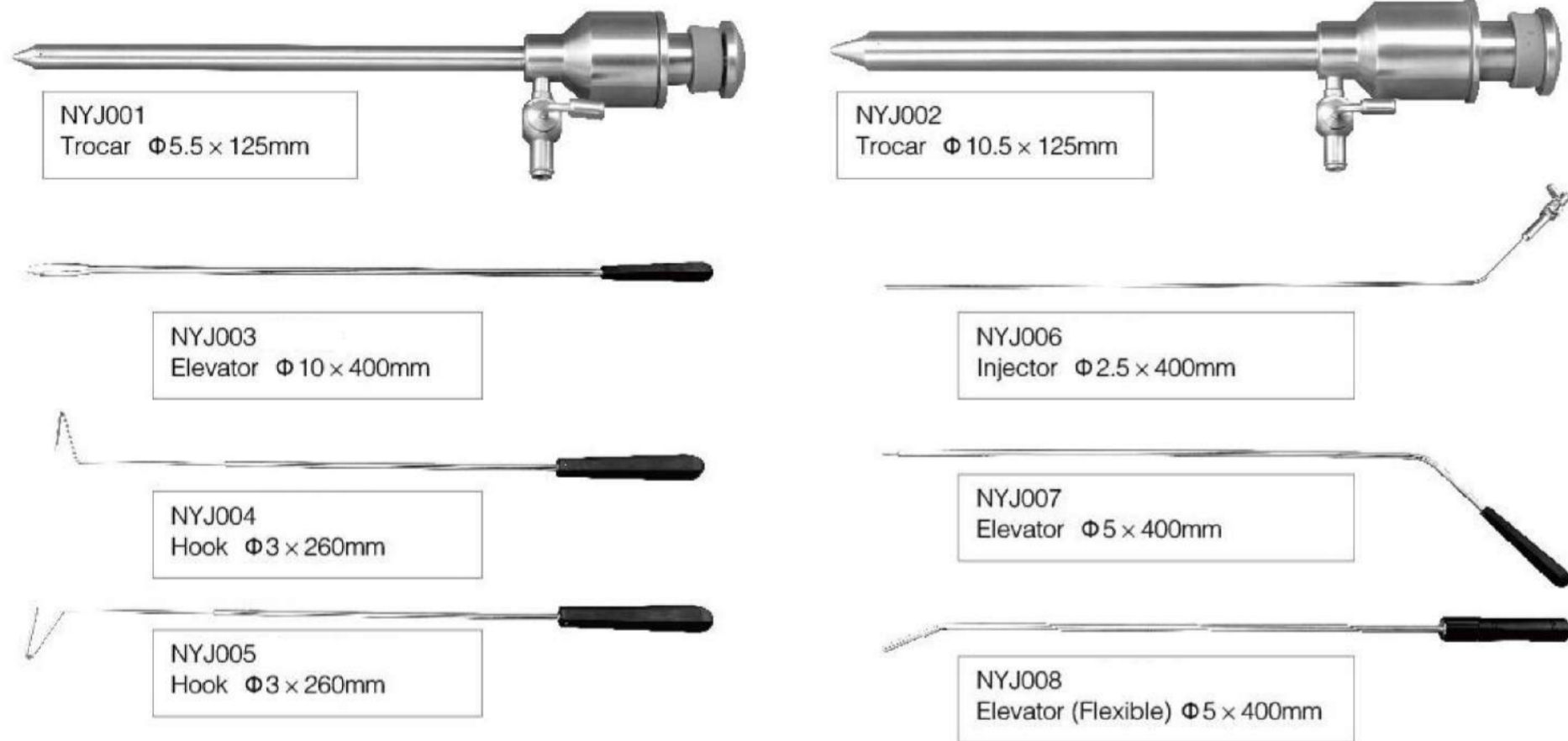

Spring Grasping Forceps

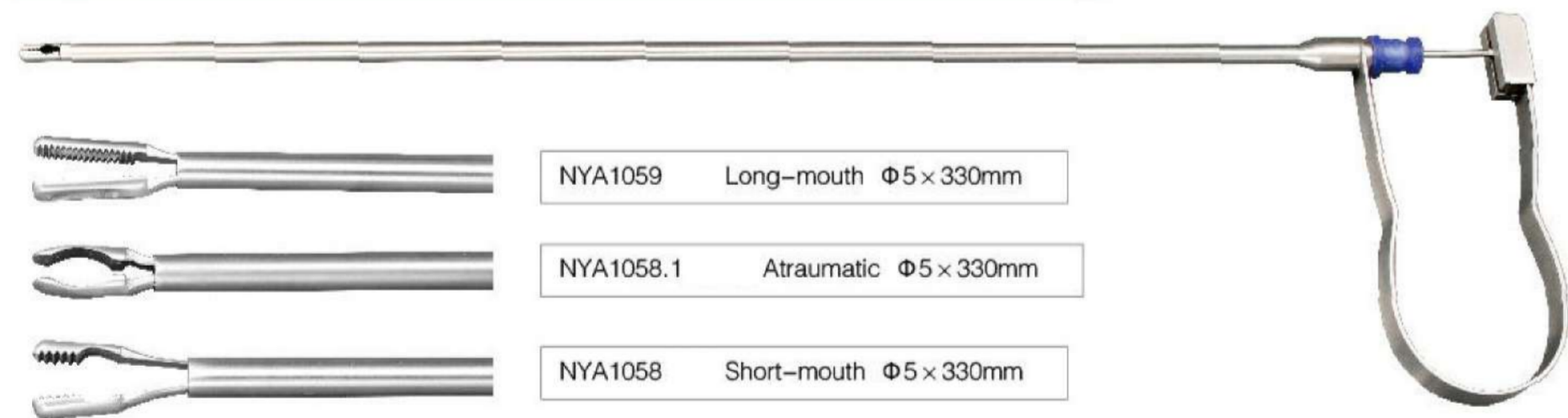

Single-hole Laparoscopy Instruments

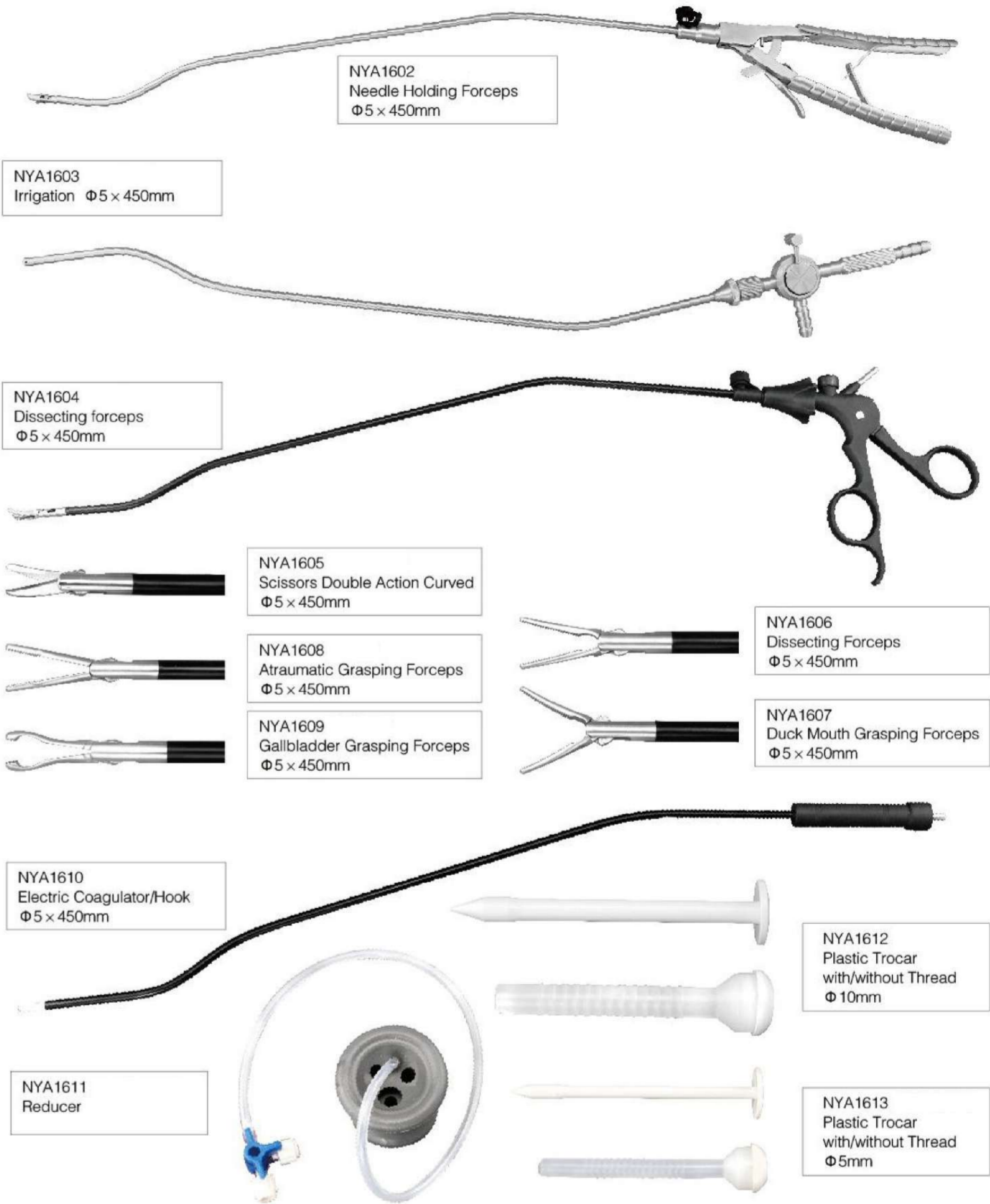
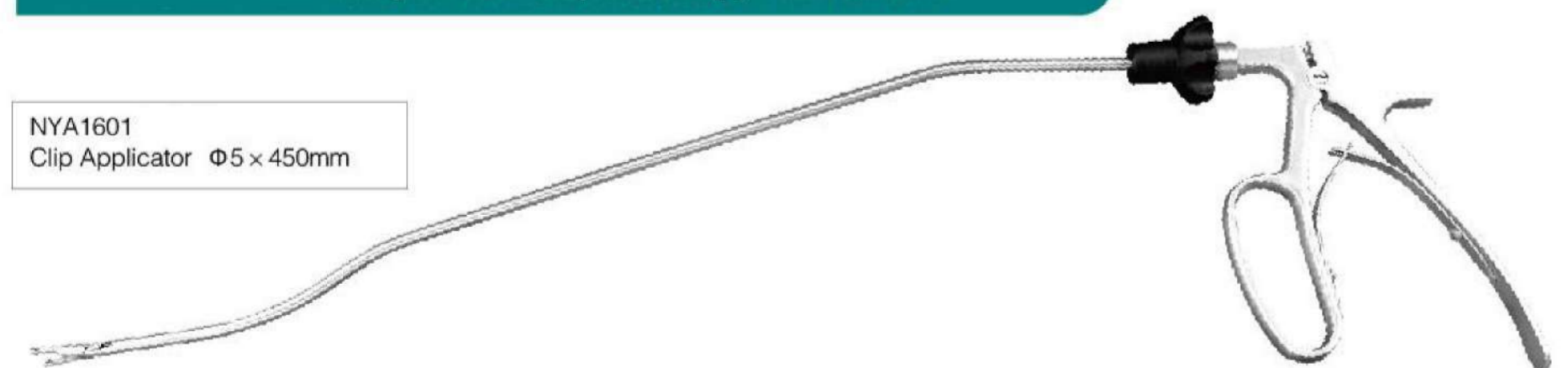

Electric Hystera-cutter Fittings (6-piece Set)

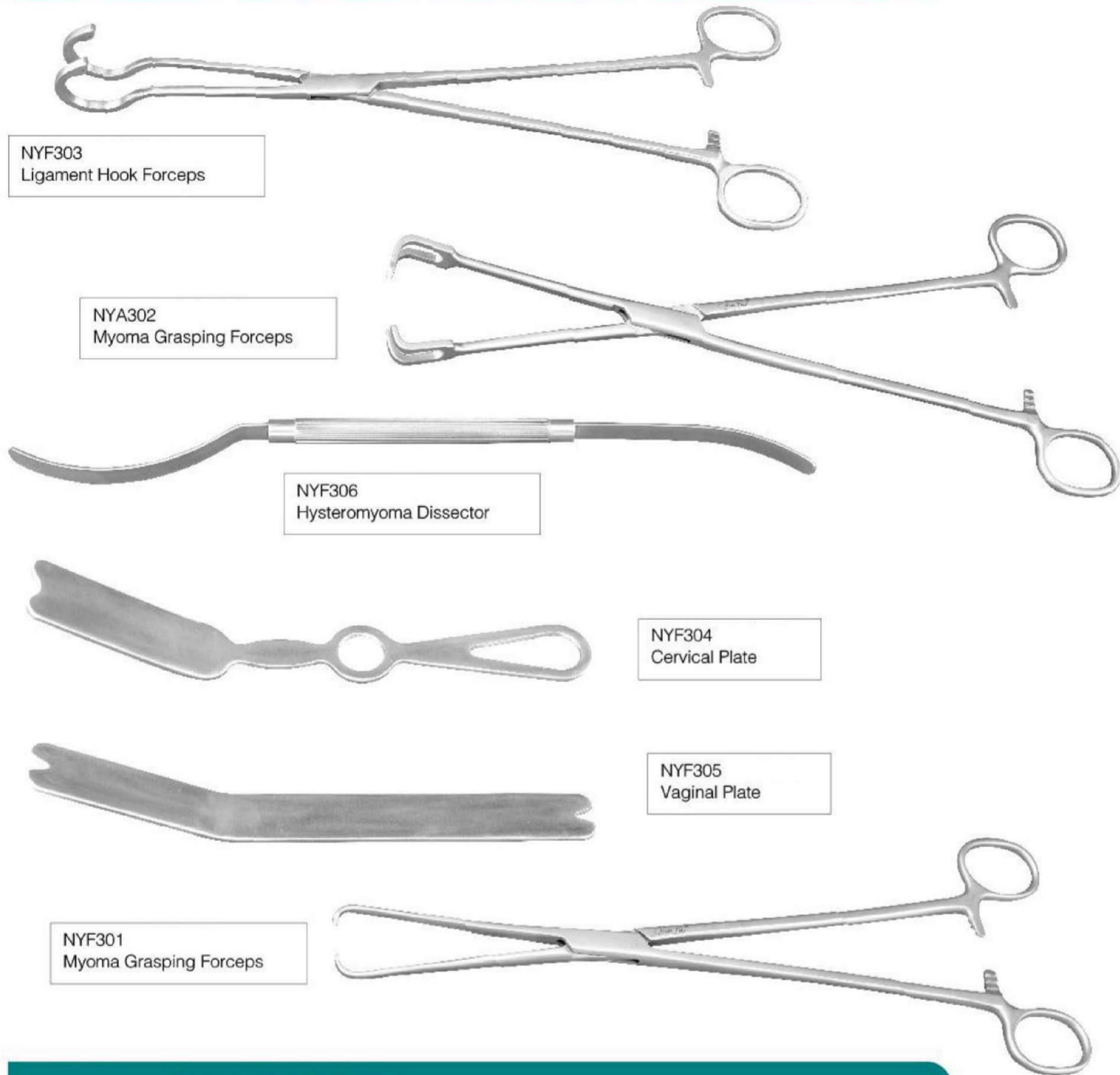

NYF303
Ligament Hook Forceps

NYA302
Myoma Grasping Forceps

NYF306
Hysteromyoma Dissector

NYF304
Cervical Plate

NYF305
Vaginal Plate

NYF301
Myoma Grasping Forceps

Trocar For Irrigation

NYA010 Trocar For Irrigation $\Phi 4 \times 180\text{mm}$

Cup Uterine Manipulator Type A

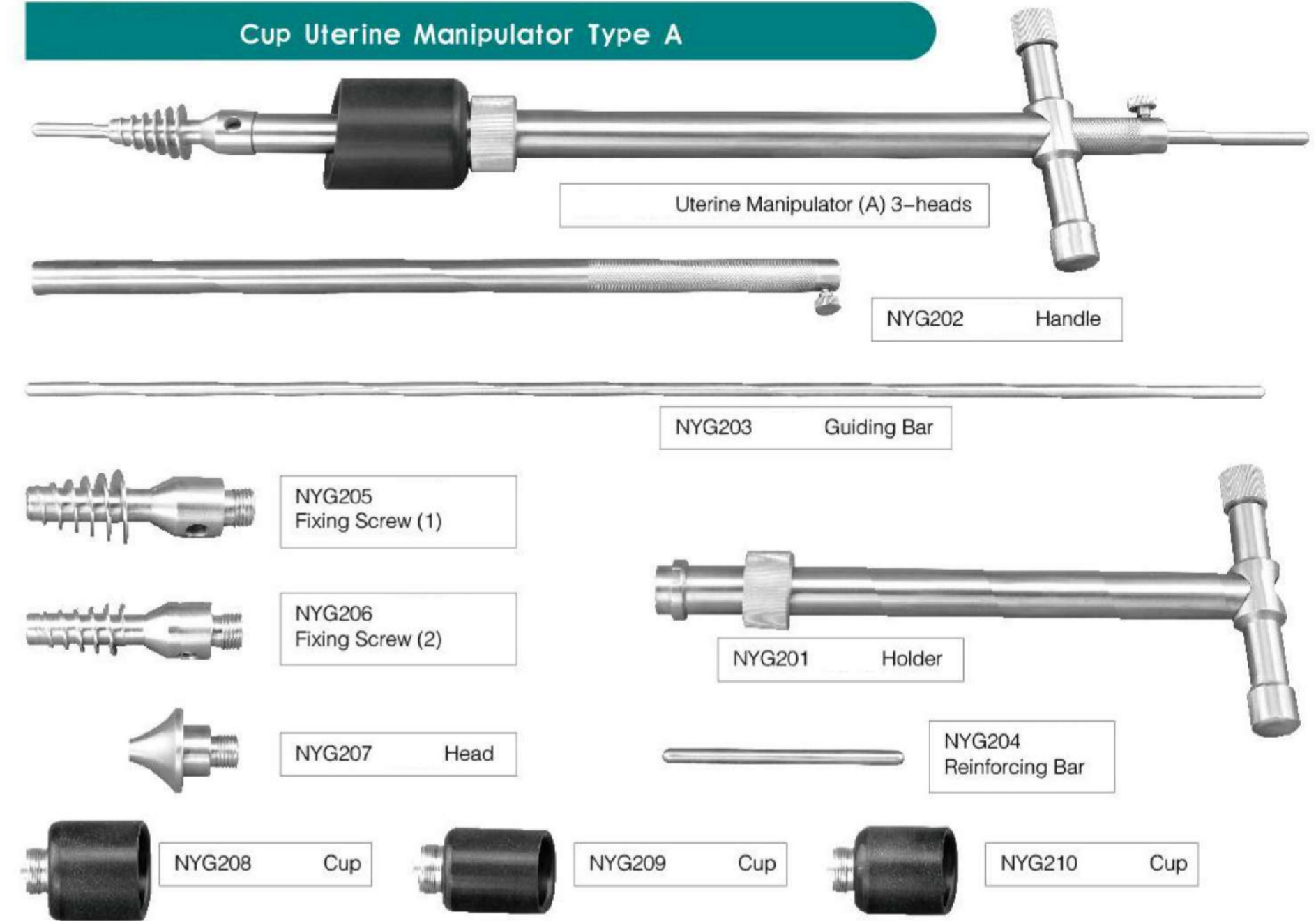

Uterine Manipulator (A) 3-heads

NYG202 Handle

NYG203 Guiding Bar

NYG205 Fixing Screw (1)

NYG206 Fixing Screw (2)

NYG201 Holder

NYG207 Head

NYG204 Reinforcing Bar

NYG208 Cup

NYG209 Cup

NYG210 Cup

Cup Uterine Manipulator Type B

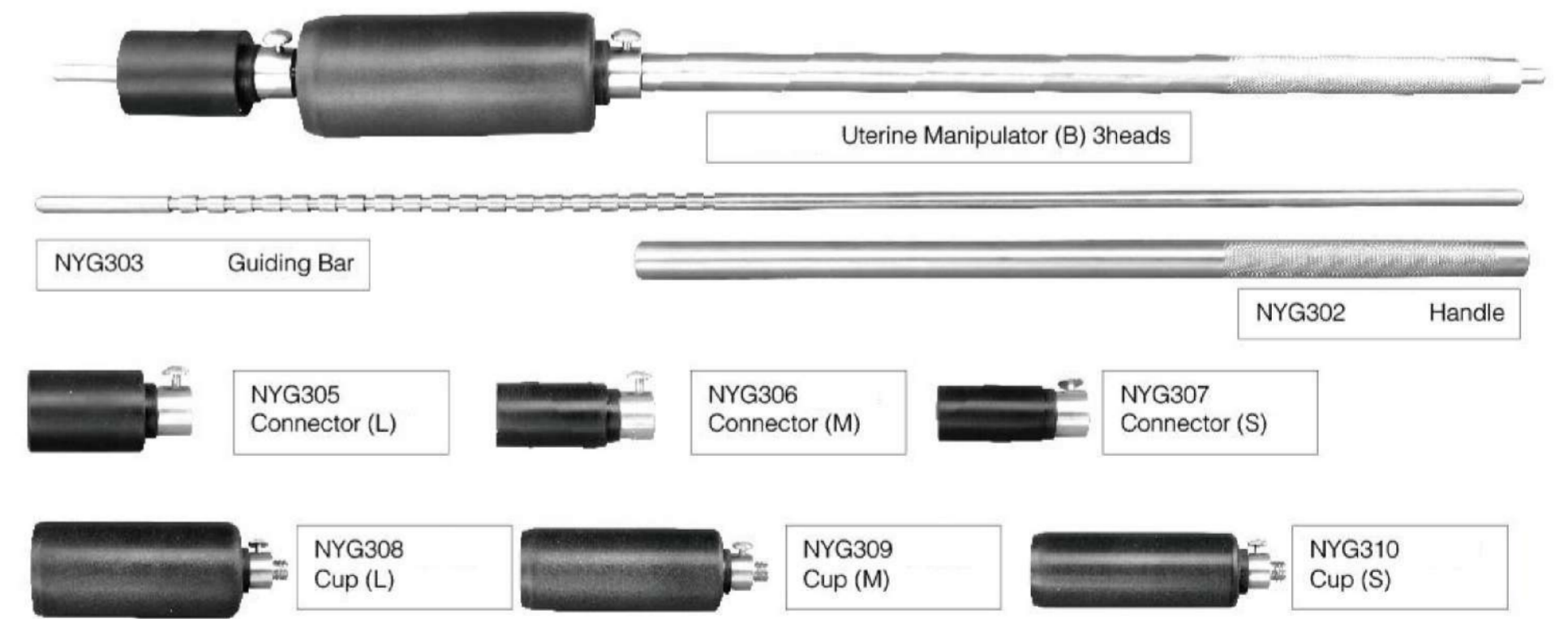

Uterine Manipulator (B) 3heads

NYG303 Guiding Bar

NYG302 Handle

NYG305 Connector (L)

NYG306 Connector (M)

NYG307 Connector (S)

NYG308 Cup (L)

NYG309 Cup (M)

NYG310 Cup (S)

Uterine Grasping Forceps

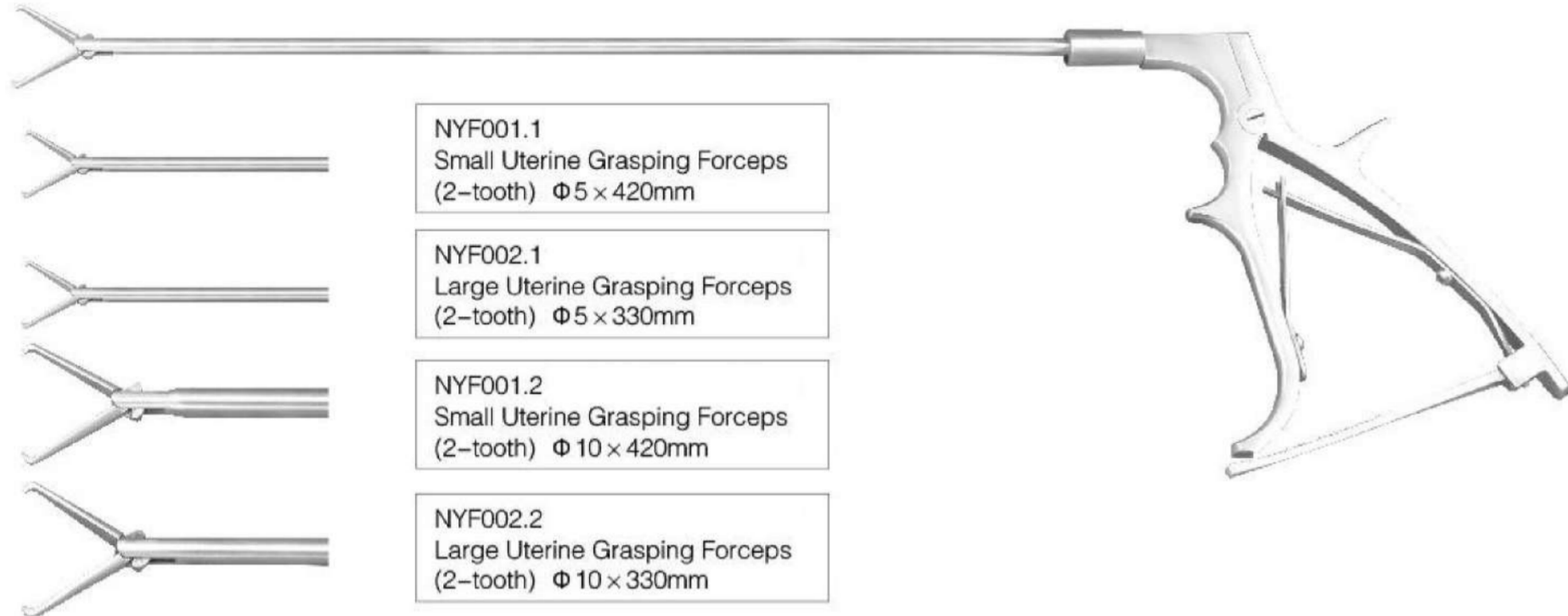

- NYF001.1
Small Uterine Grasping Forceps
(2-tooth) $\Phi 5 \times 420\text{mm}$
- NYF002.1
Large Uterine Grasping Forceps
(2-tooth) $\Phi 5 \times 330\text{mm}$
- NYF001.2
Small Uterine Grasping Forceps
(2-tooth) $\Phi 10 \times 420\text{mm}$
- NYF002.2
Large Uterine Grasping Forceps
(2-tooth) $\Phi 10 \times 330\text{mm}$

Multifunctional Uterine Manipulator

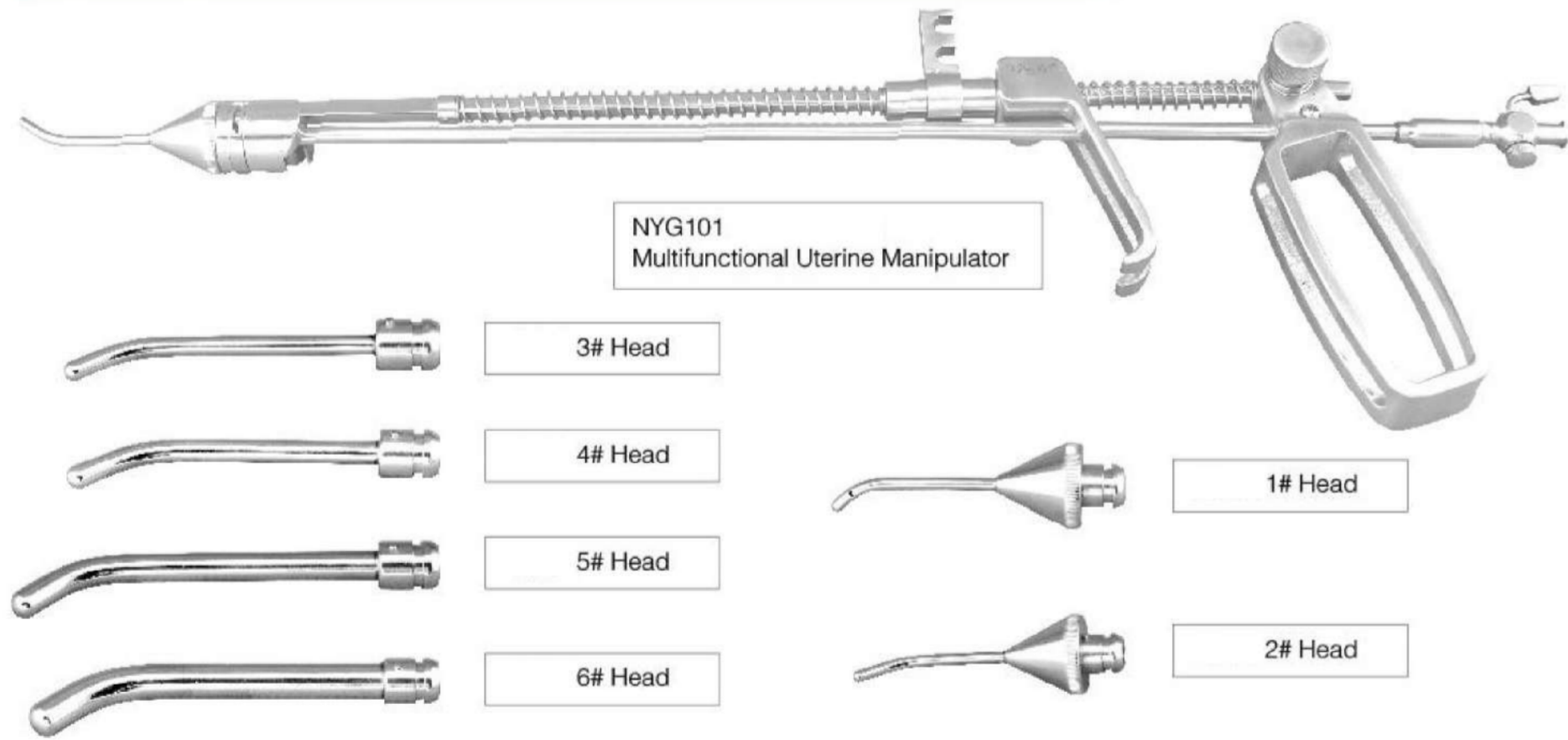

NYG101
Multifunctional Uterine Manipulator

3# Head

4# Head

5# Head

6# Head

1# Head

2# Head

Uterine Manipulator



NYF020
Uterine Manipulator

Sinoscopy Instruments

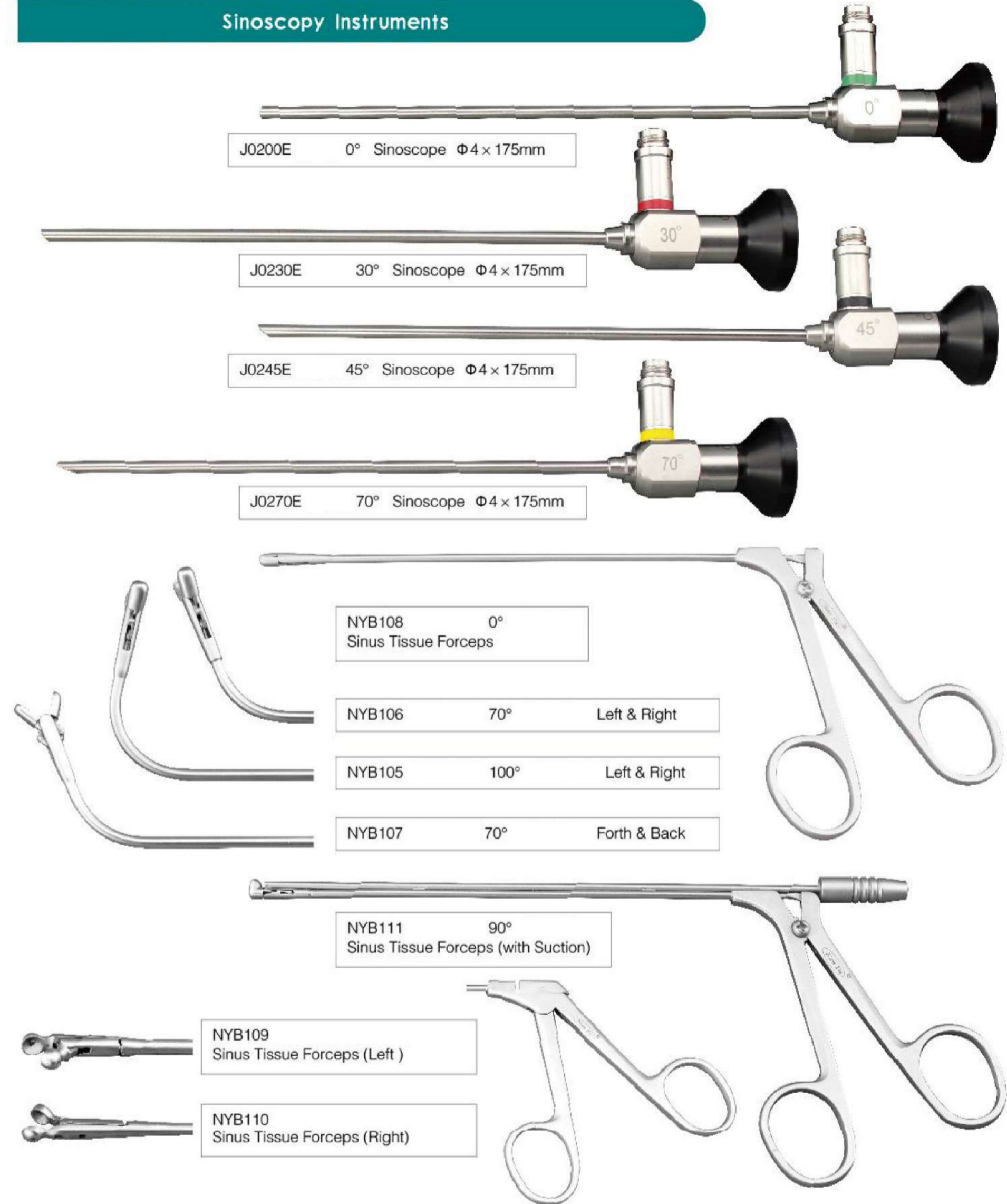

J0200E 0° Sinoscope $\Phi 4 \times 175\text{mm}$

J0230E 30° Sinoscope $\Phi 4 \times 175\text{mm}$

J0245E 45° Sinoscope $\Phi 4 \times 175\text{mm}$

J0270E 70° Sinoscope $\Phi 4 \times 175\text{mm}$

NYB108 0°
Sinus Tissue Forceps

NYB106 70° Left & Right

NYB105 100° Left & Right

NYB107 70° Forth & Back

NYB111 90°
Sinus Tissue Forceps (with Suction)

NYB109
Sinus Tissue Forceps (Left)

NYB110
Sinus Tissue Forceps (Right)

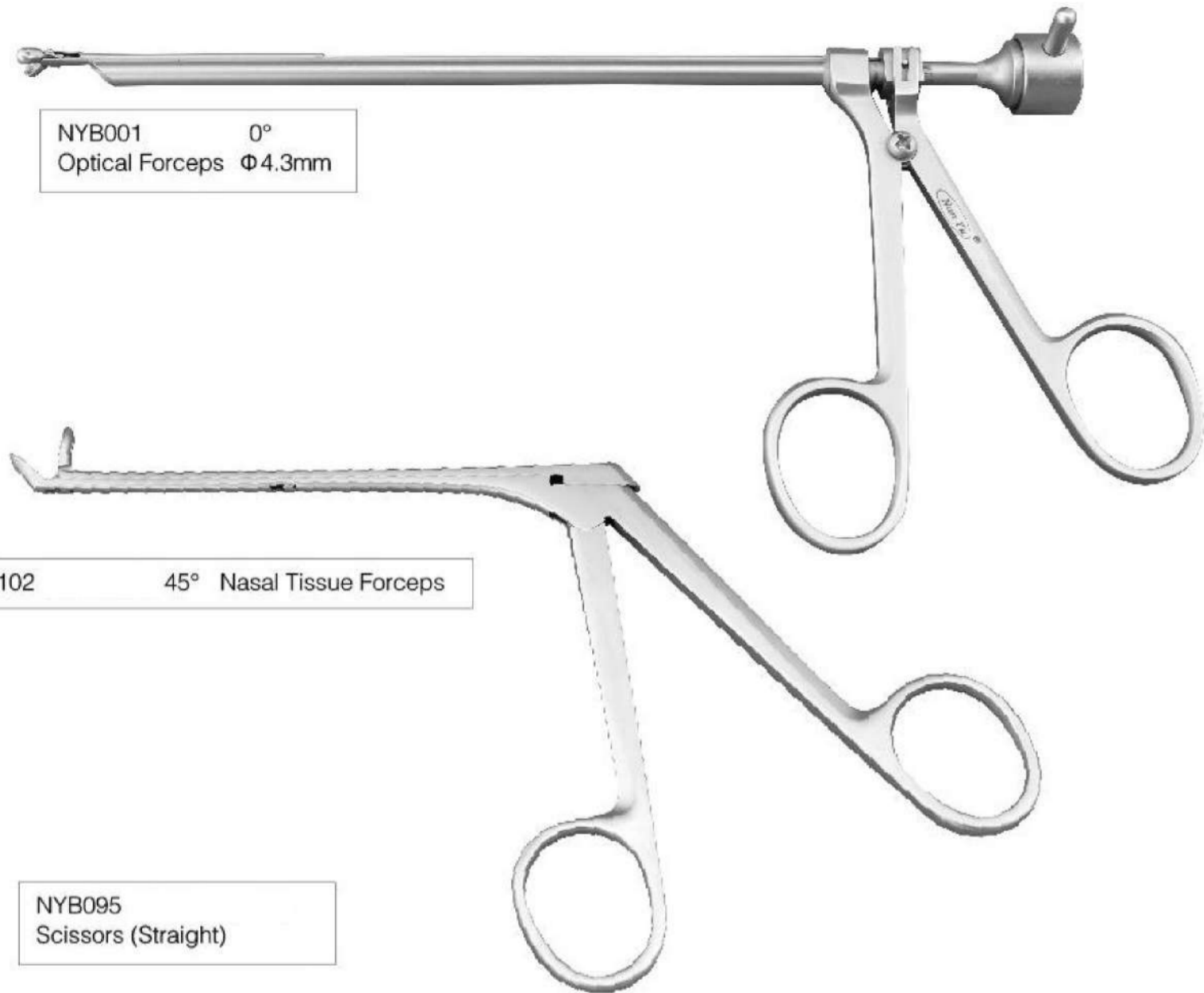

NYB001 0°
Optical Forceps Φ 4.3mm

NYB102 45° Nasal Tissue Forceps



NYB095
Scissors (Straight)



NYB096
Scissors (Left)



NYB097
Scissors (Right)



NYB098
Nasal Rongeur (Forth Biting)



NYB099
Nasal Rongeur (Back Biting)



NYB100 0°
Nasal Tissue Forceps



NYB101 30°
Nasal Tissue Forceps



NYB102 45°
Nasal Tissue Forceps



NYB103 鼻腔组织钳 90°
Nasal Tissue Forceps



NYB104
Nasal Polyp Forceps



NYB028
Nasal Foreign Body Forceps



NYB094.1 0°
Nasal Ethmoid Rongeur



NYB094.2 30°
Nasal Ethmoid Rongeur

Sinoscopy Instruments Fittings (Optional)

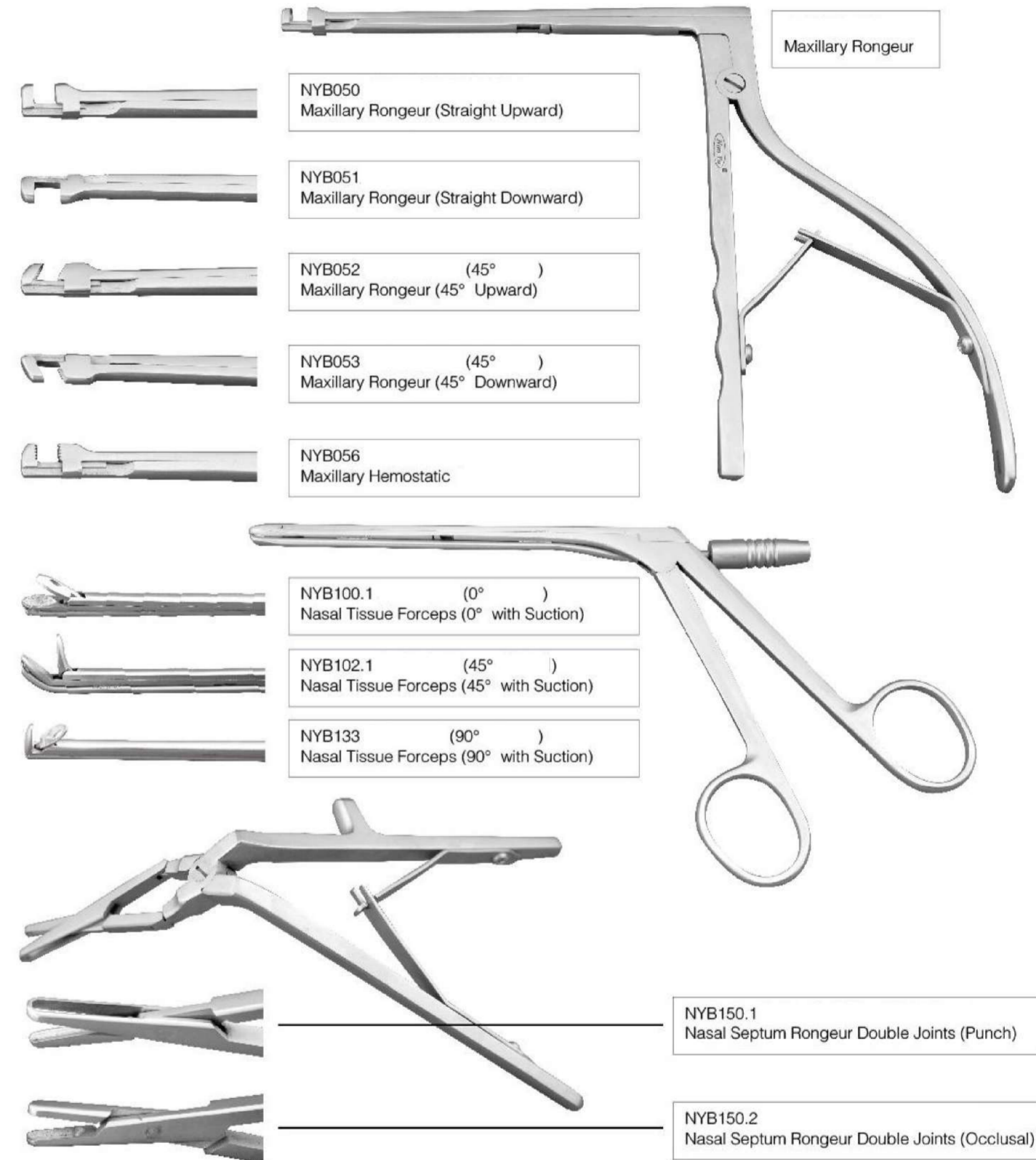

Maxillary Rongeur

NYB050
Maxillary Rongeur (Straight Upward)

NYB051
Maxillary Rongeur (Straight Downward)

NYB052 (45°)
Maxillary Rongeur (45° Upward)

NYB053 (45°)
Maxillary Rongeur (45° Downward)

NYB056
Maxillary Hemostatic

NYB100.1 (0°)
Nasal Tissue Forceps (0° with Suction)

NYB102.1 (45°)
Nasal Tissue Forceps (45° with Suction)

NYB133 (90°)
Nasal Tissue Forceps (90° with Suction)





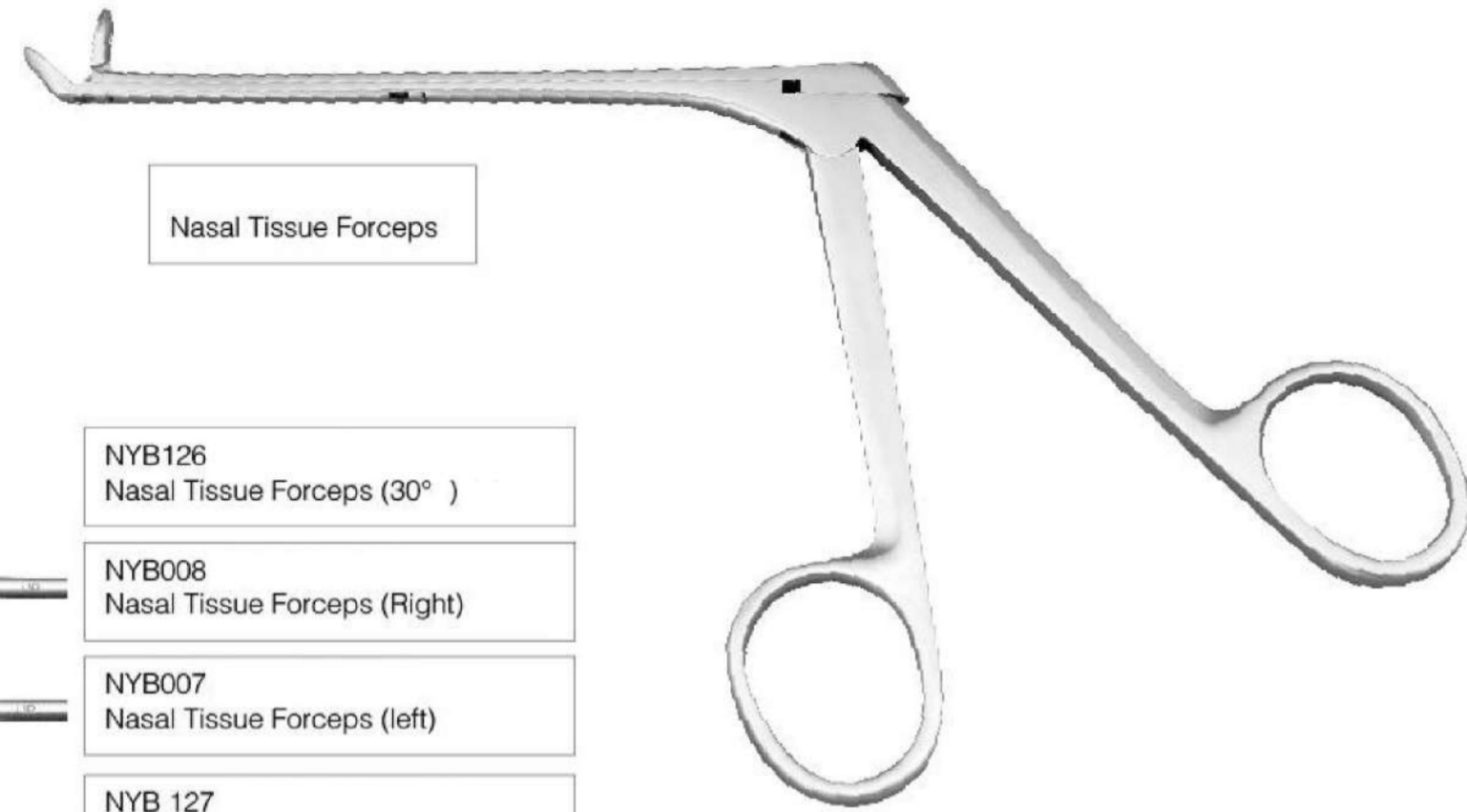





NYB150.1
Nasal Septum Rongeur Double Joints (Punch)

NYB150.2
Nasal Septum Rongeur Double Joints (Occlusal)



Nasal Tissue Forceps

-  NYB126
Nasal Tissue Forceps (30°)
-  NYB008
Nasal Tissue Forceps (Right)
-  NYB007
Nasal Tissue Forceps (left)
-  NYB 127
Nasal Tissue Forceps (30° L)
-  NYB 128
Nasal Tissue Forceps (0° L)
-  NYB099.2
Nasal Tissue Forceps (Right)
-  NYB099.1
Nasal Tissue Forceps (Left)
-  NYB029
Foreign Body Forceps
-  NYB129
Nasal Cutting Forceps (0°)
-  NYB130
Nasal cutting forceps (30°)
-  NYB010.2
Nasal Ethmoidrongeur
(0° Pointed Head)
-  NYB011.2
Nasal Ethmoidrongeur
(30° Pointed Head)
-  NYB012.2
Nasal Ethmoidrongeur
(45° Pointed Head)

-  NYB094.4
Nasal Ethmoidrongeur
(90° Big Blunt Head)
-  NYB132
Nasal Tissue Forceps (45°)
-  NYB131
Nasal Tissue Forceps (0°)
-  NYB136
Nasal Ethmoid Rongeur
(45° Blunt Head)
-  NYB135
Nasal Ethmoid Rongeur
(30° Blunt Head)
-  NYB135.1
Nasal Ethmoid Rongeur
(0° Blunt Head)
-  NYB134
Nasal Ethmoid Rongeur
(30° Big Blunt Head)
-  NYB137.1
Nasal Ethmoid Rongeur
(0° Pointed Head)
-  NYB137
Nasal Ethmoid Rongeur
(30° Pointed Head)
-  NYB138
Nasal Ethmoid Rongeur
(45° Pointed Head)

Sinoscopy Instruments Fittings (Optional)

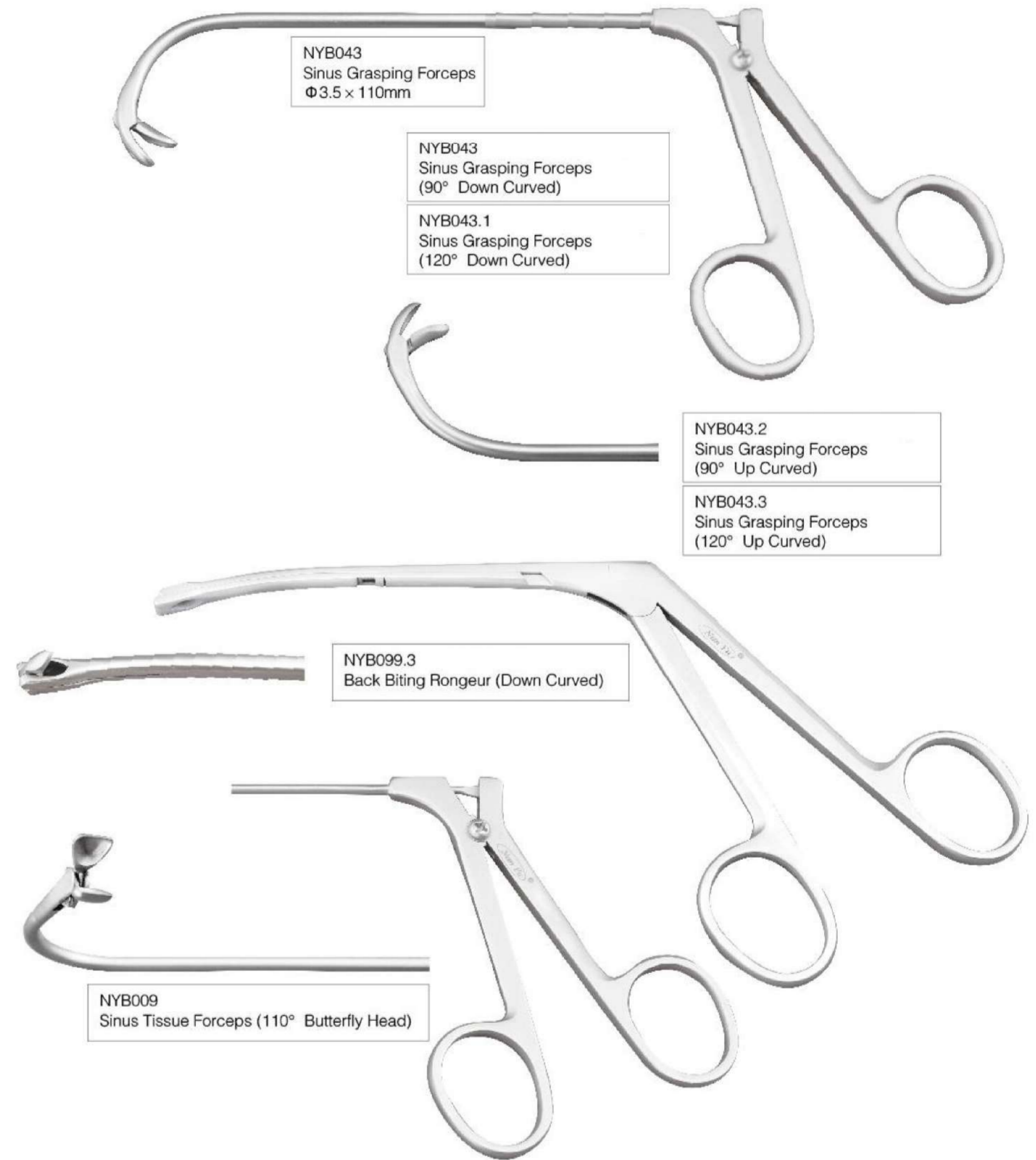

NYB043
Sinus Grasping Forceps
Φ3.5 × 110mm

NYB043
Sinus Grasping Forceps
(90° Down Curved)

NYB043.1
Sinus Grasping Forceps
(120° Down Curved)

NYB043.2
Sinus Grasping Forceps
(90° Up Curved)

NYB043.3
Sinus Grasping Forceps
(120° Up Curved)

NYB099.3
Back Biting Rongeur (Down Curved)

NYB009
Sinus Tissue Forceps (110° Butterfly Head)

Sinoscopy Instruments Fittings (Optional)

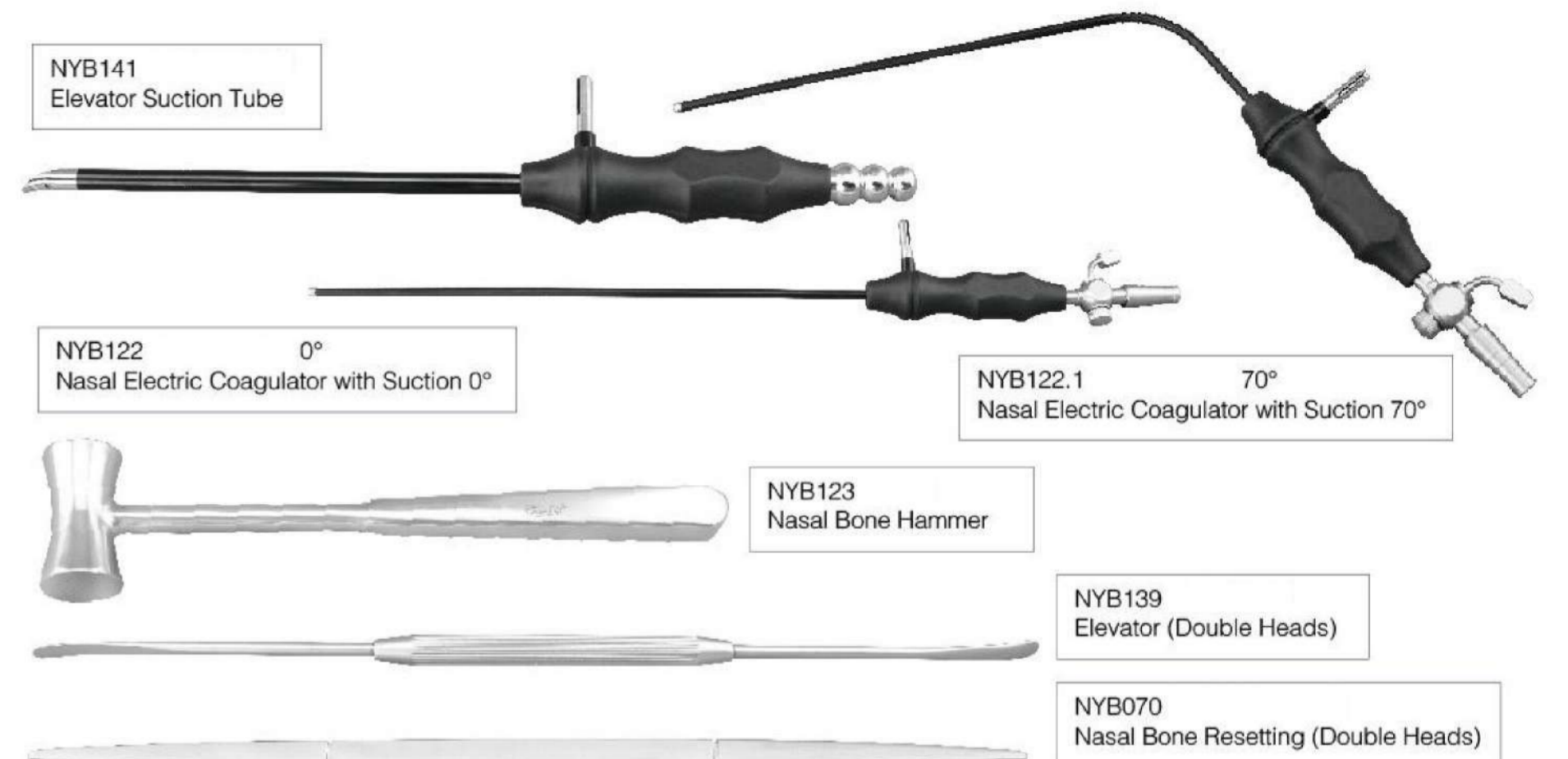
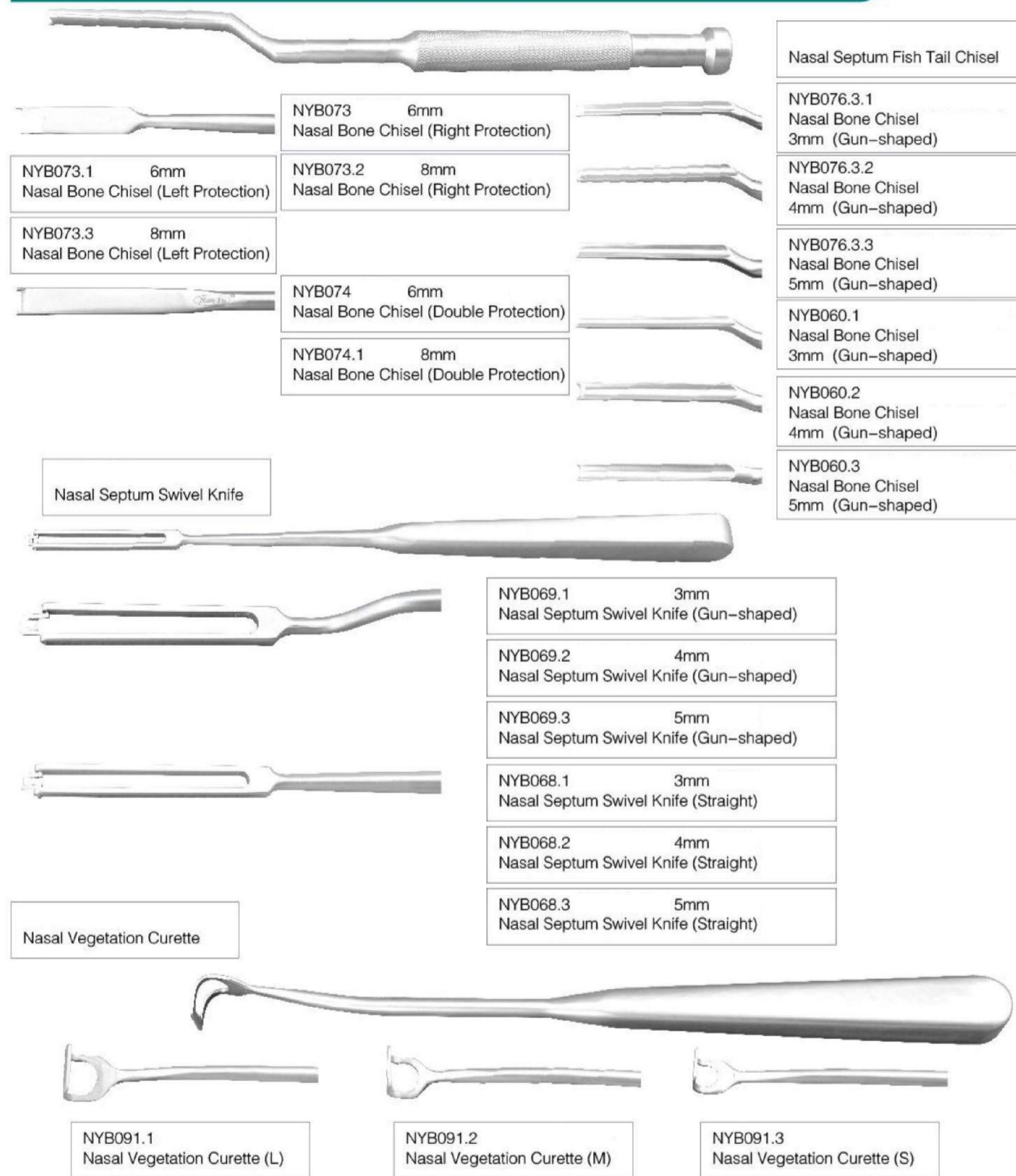

Sinoscopy Instruments Fittings (Optional)

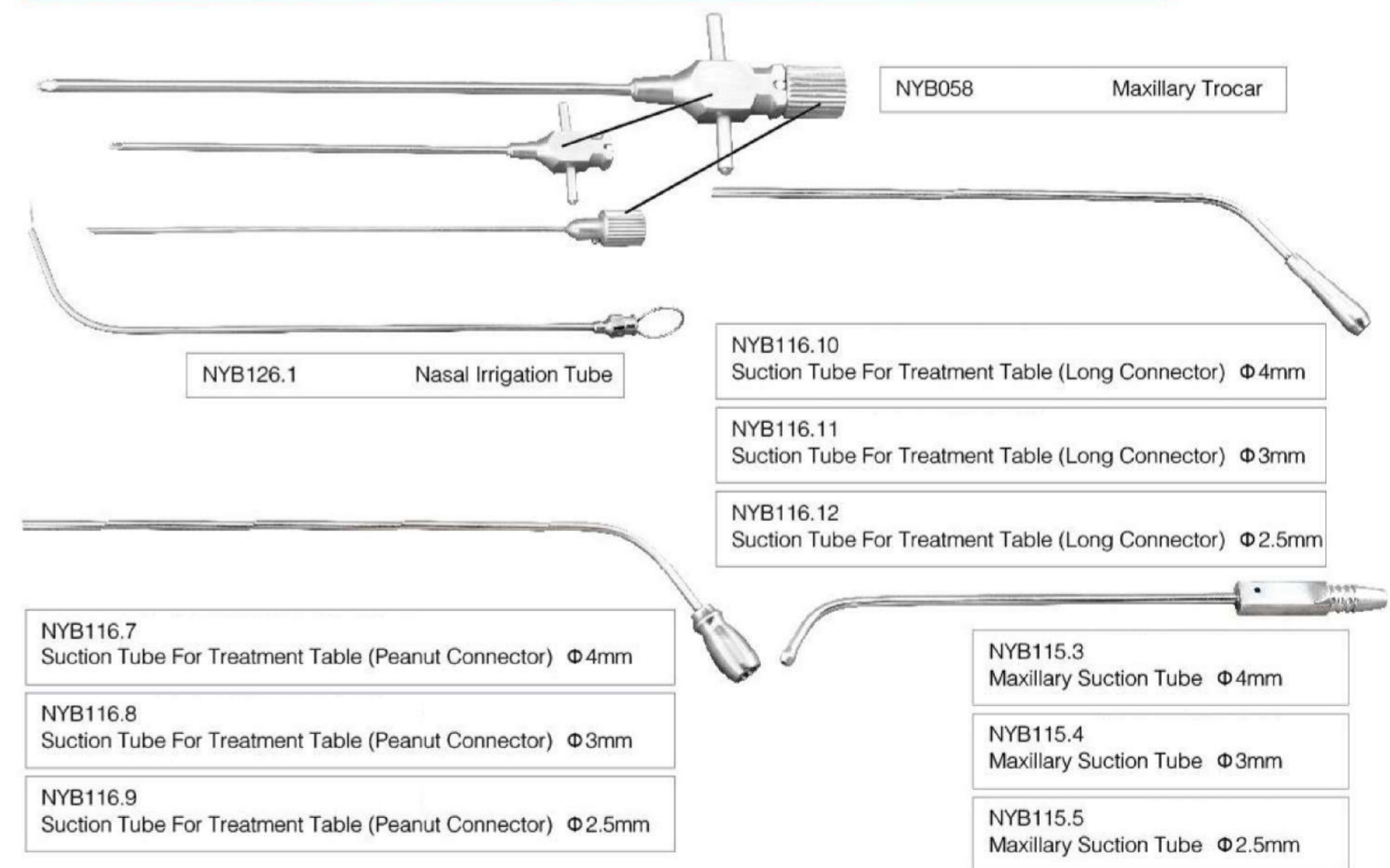

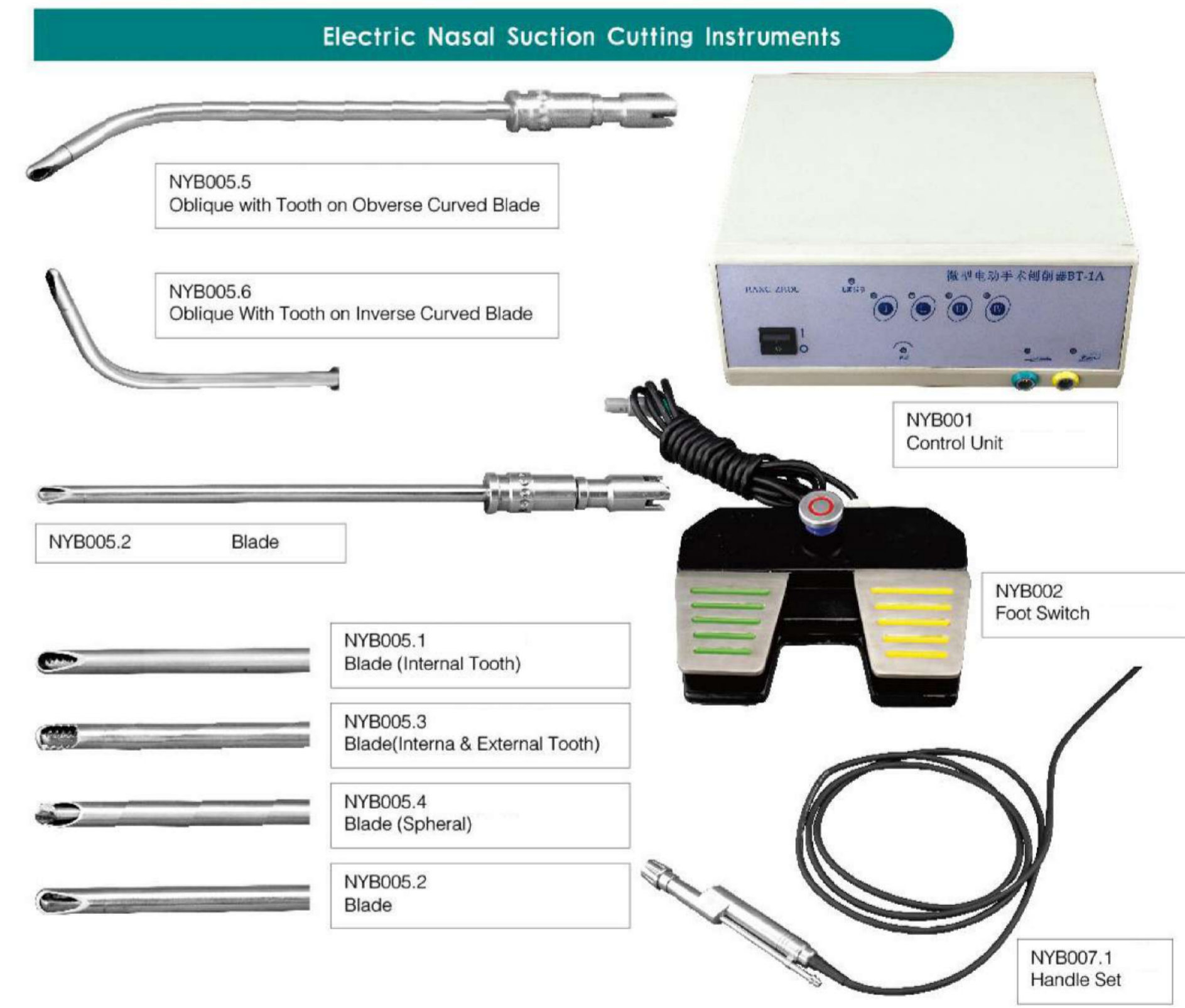
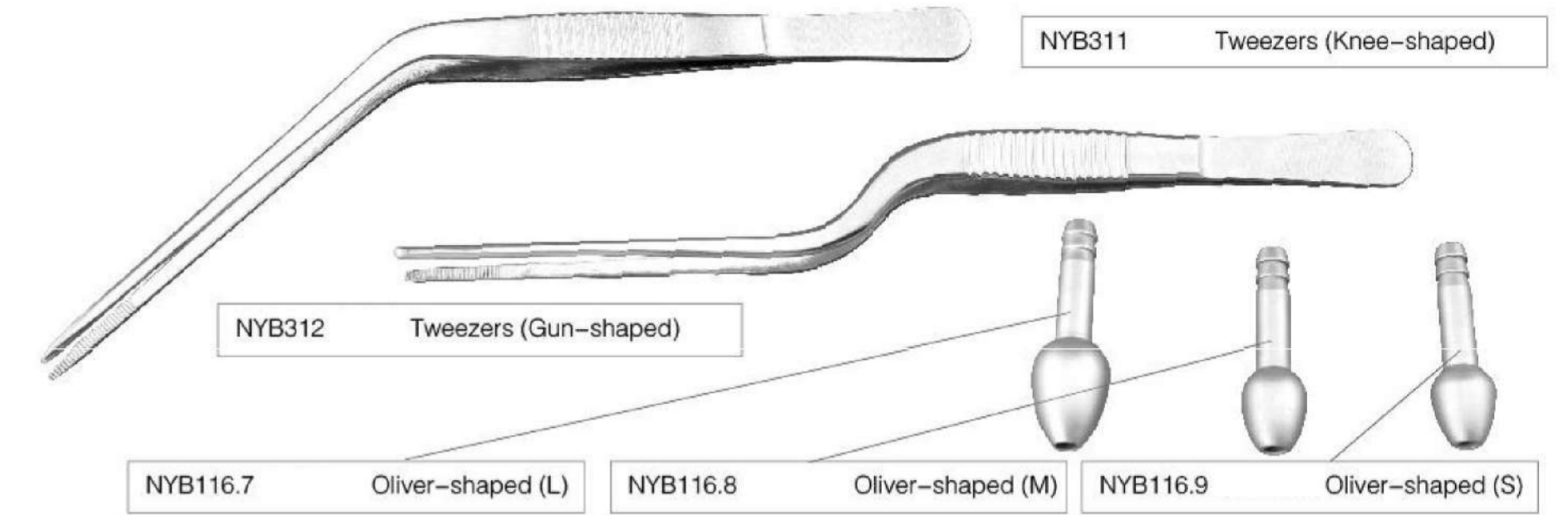
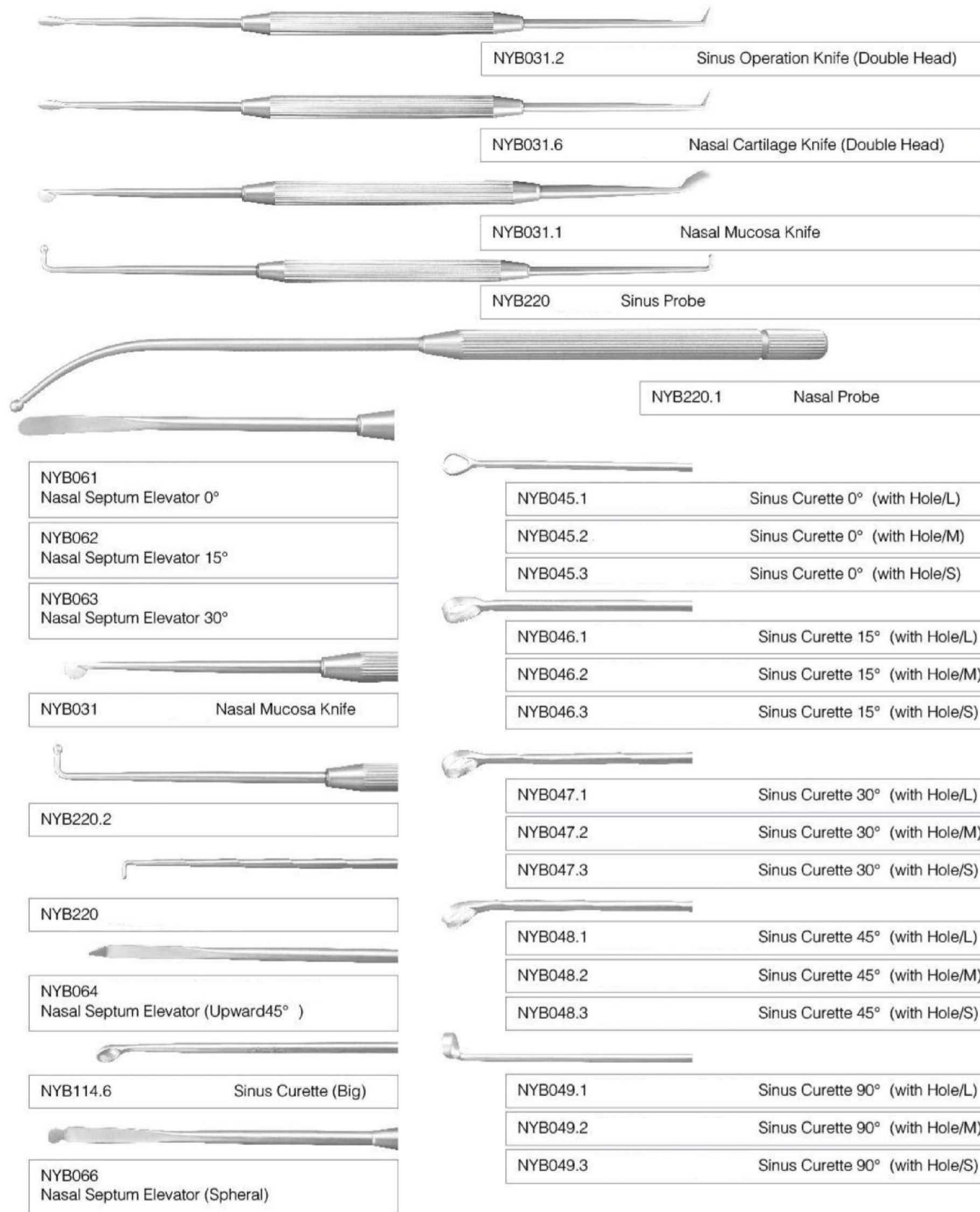

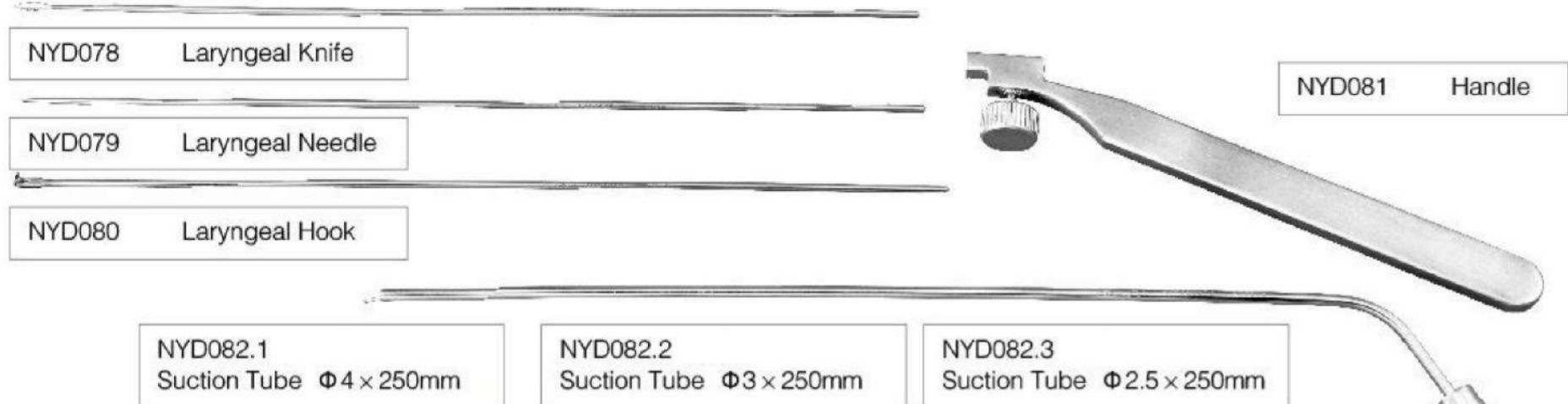

Laryngeal Instruments Fittings (Optional)

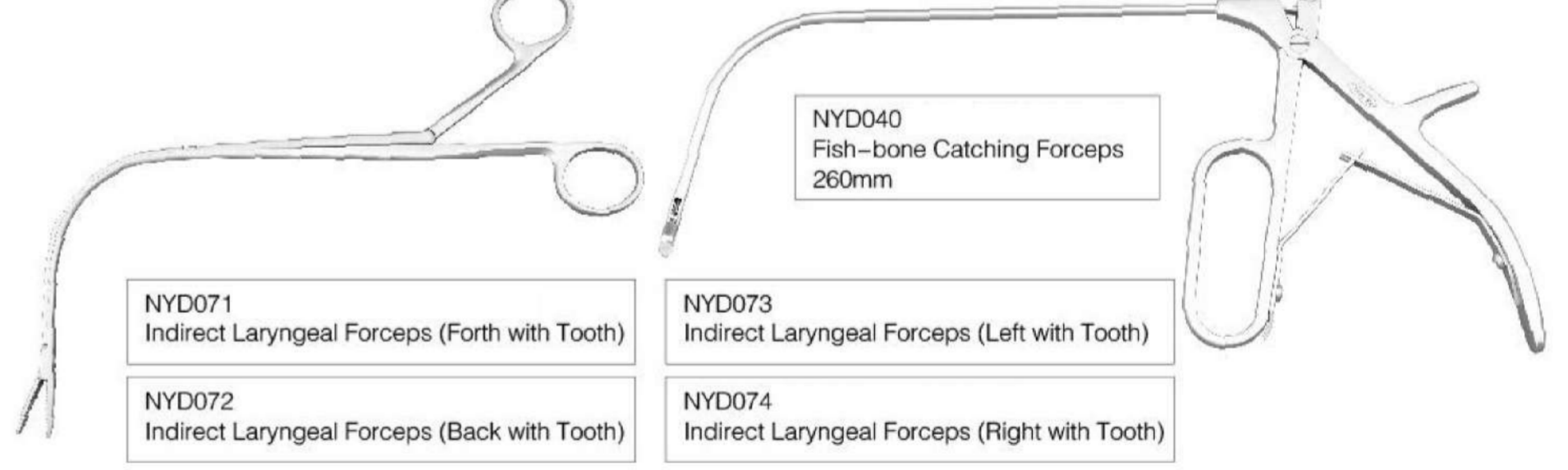
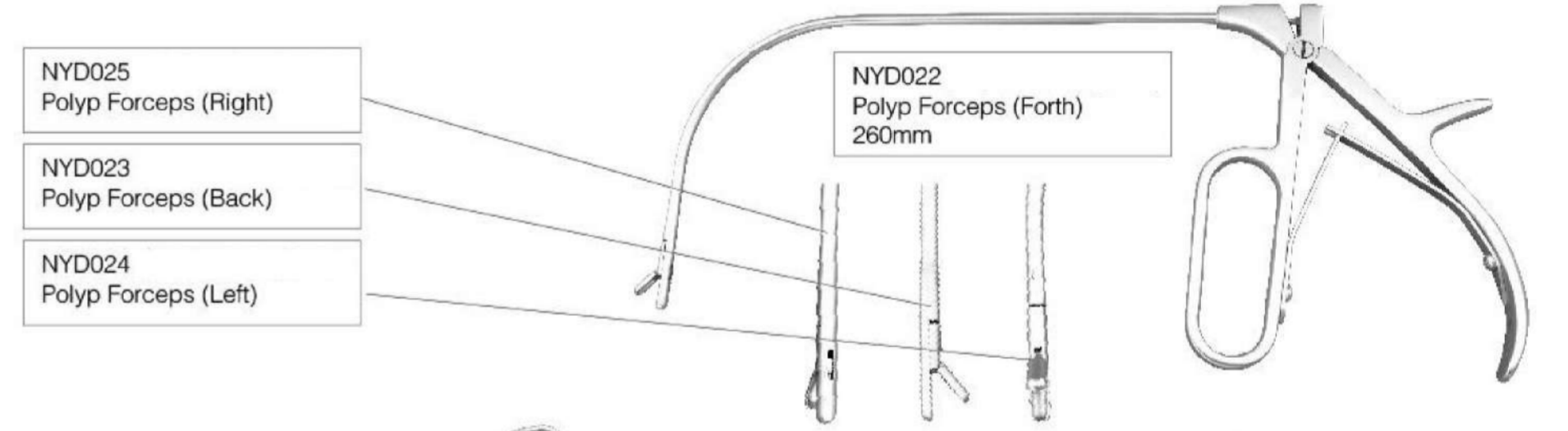
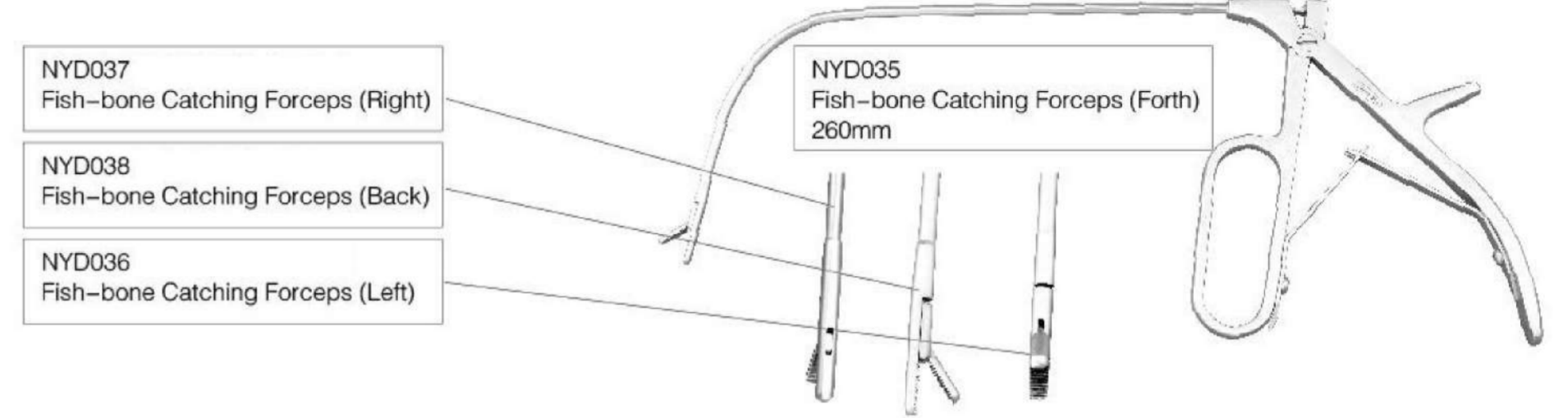
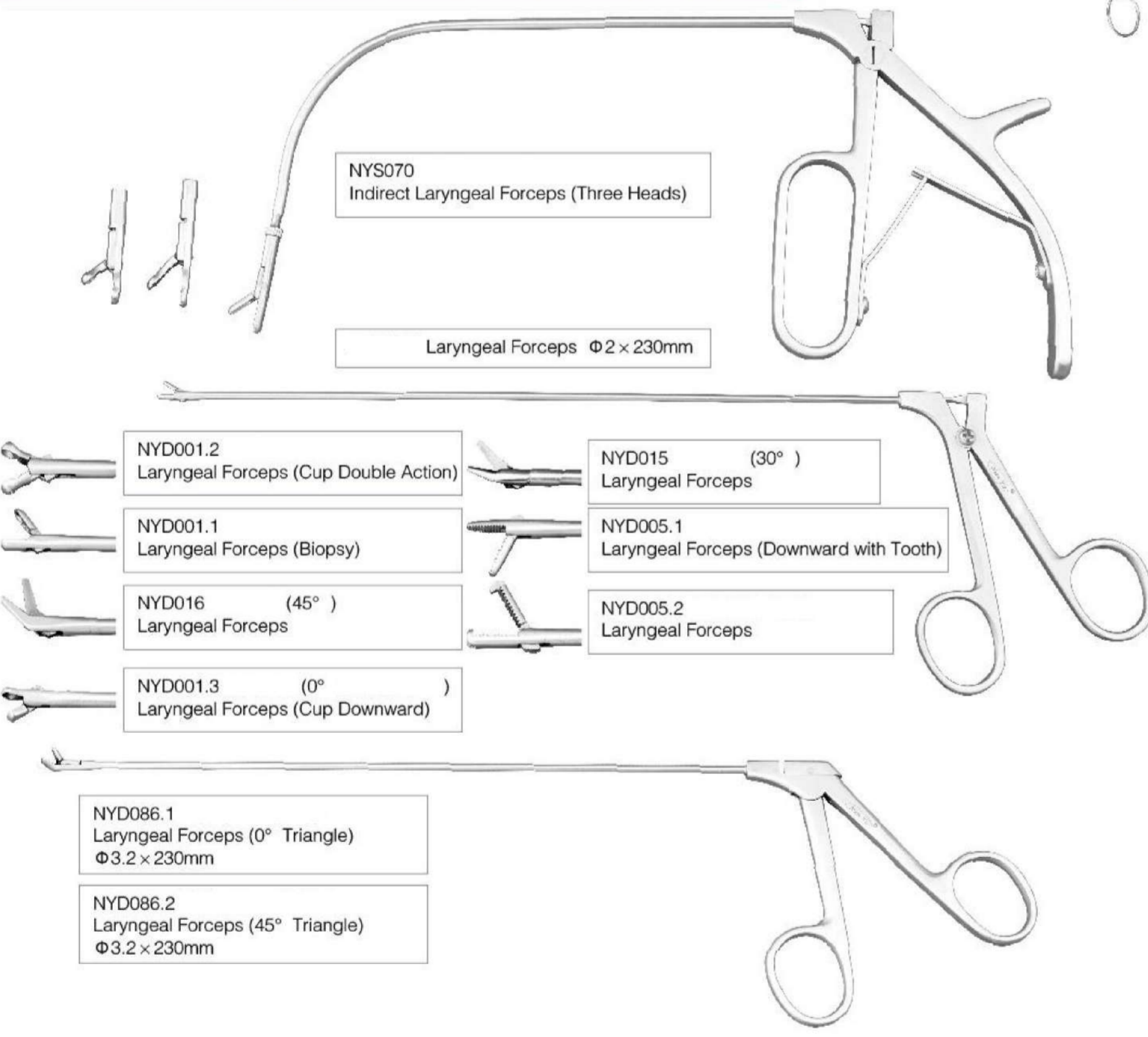

Tonsil Instrument

NYD067
Tonsil Guillotine (Three Heads)

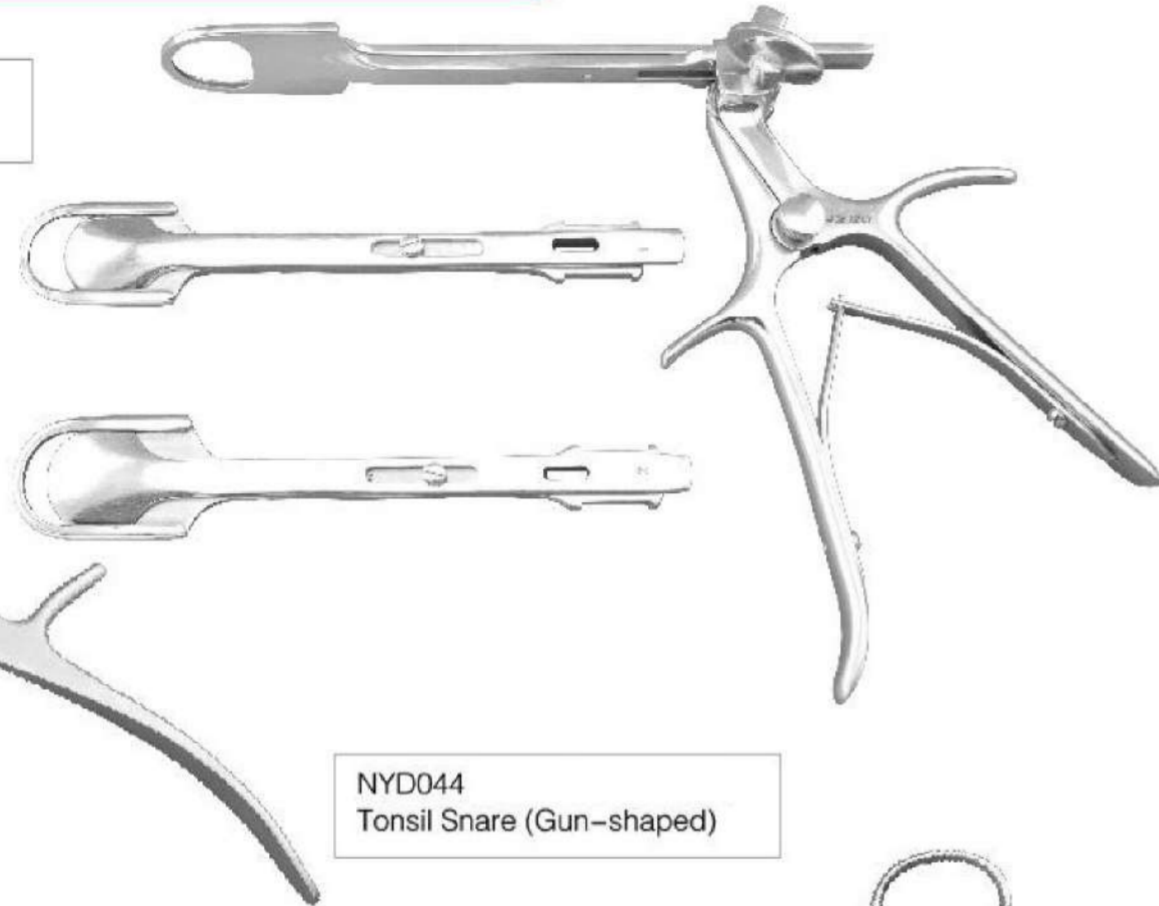

NYD044
Tonsil Snare (Gun-shaped)

Wire-steel

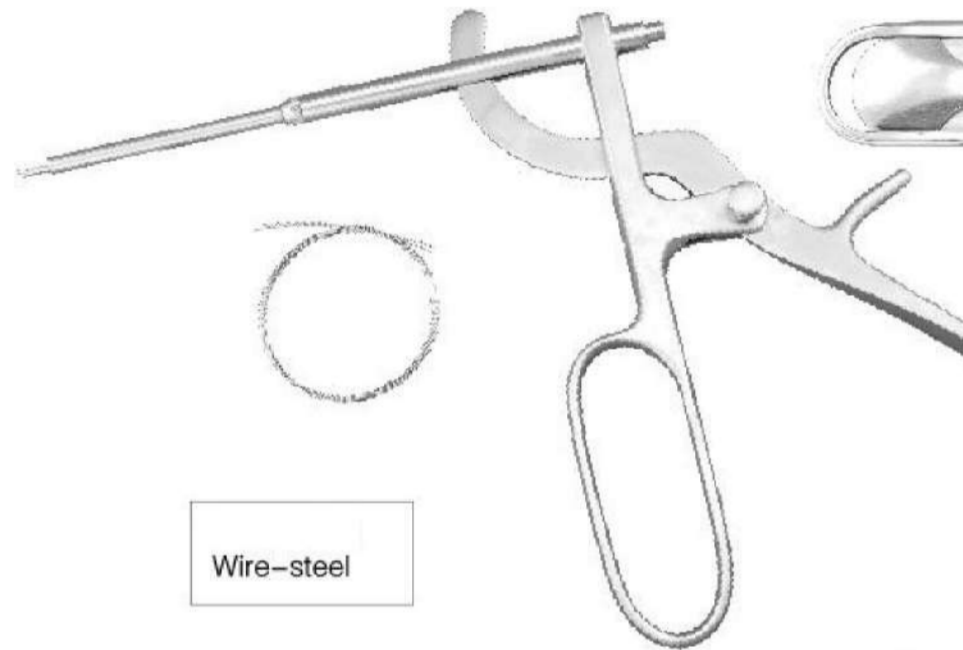

NYD043
Laryngeal Polyp Snare

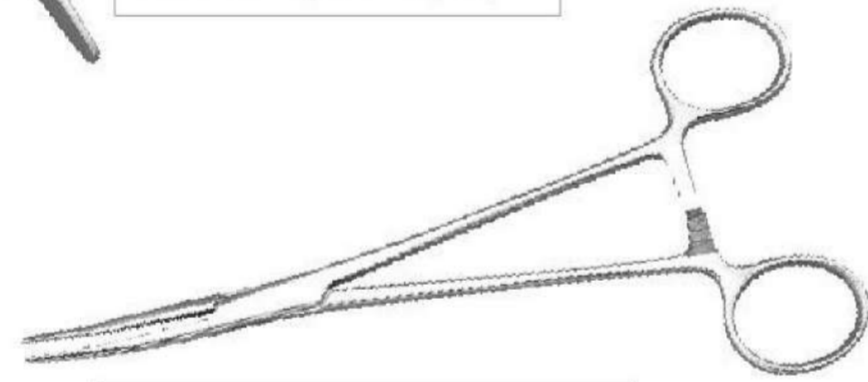

NYD049
Tonsil Hemostatic Forceps (Curved)



NYD047
Tonsil Holding Forceps

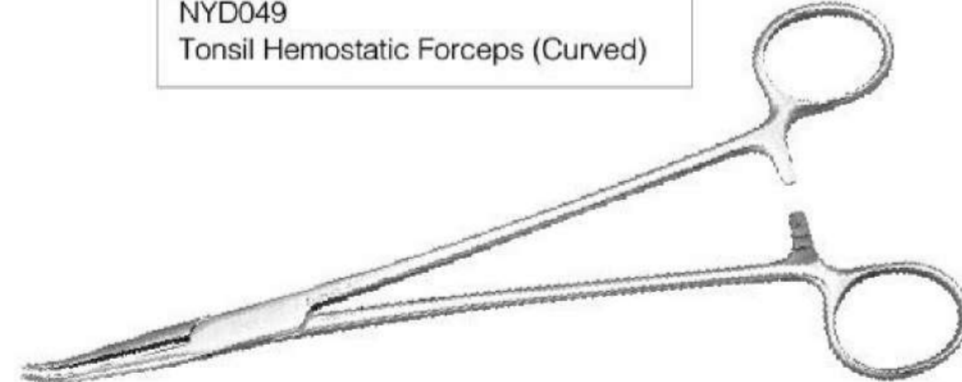

NYD050
Tonsil Hemostatic Forceps (Curved)

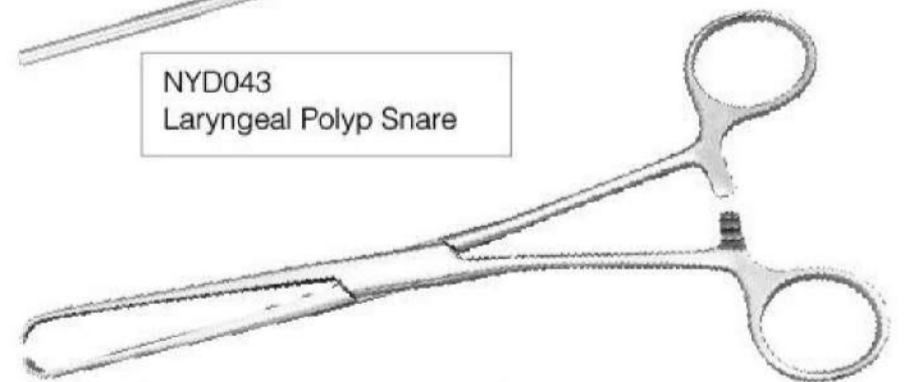

NYD048
Tonsil Scissors

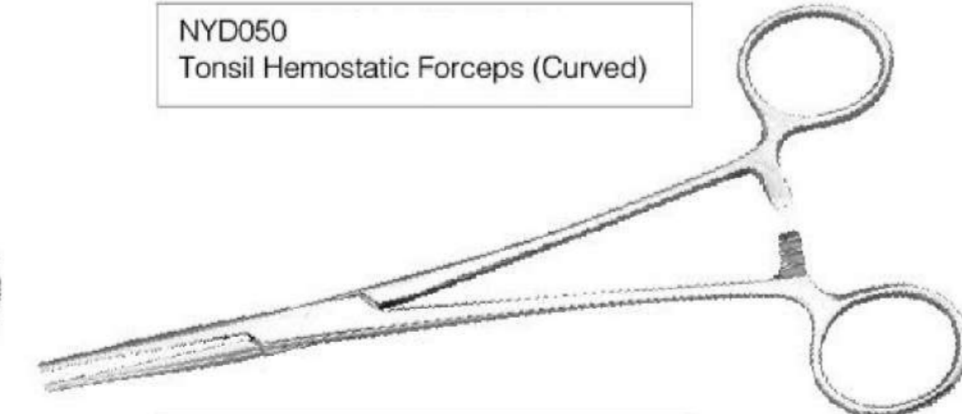

NYD051
Tonsil Hemostatic Forceps (Straight)

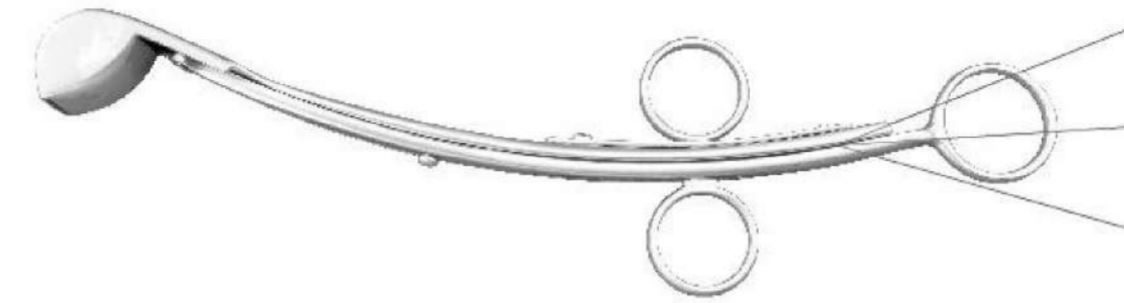

NYD052.1
Adenoid Vegetation Guillotine (Cassette/L)



NYD052.2
Adenoid Vegetation Guillotine (Cassette/M)



NYD052.3
Adenoid Vegetation Guillotine (Cassette/S)



NYD054
Tonsil Needle (Curved)

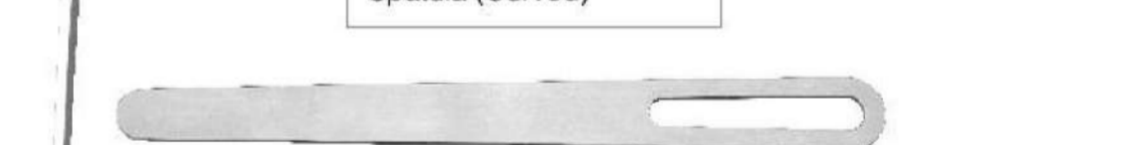

NYD045
Spatula (Curved)



NYD046
Spatula



NYD056
Tonsil Sponge Forceps



NYD057
Tongue Grasping Forceps

NYD058
Anesthetic Mouth-gag (5 x 1)

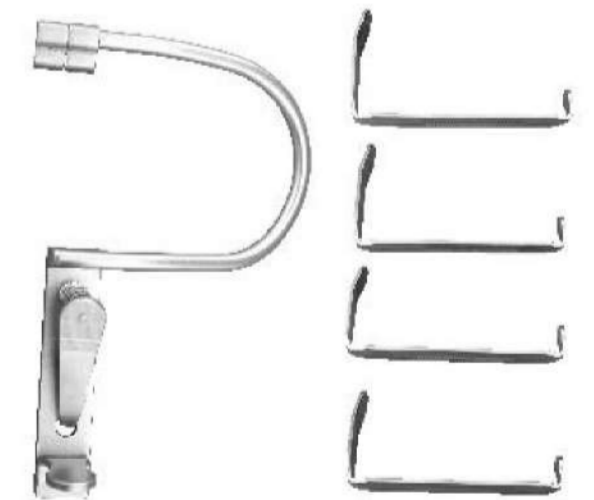

NYD059.1
Indirect Laryngoscope Φ 22



NYD059.2
Indirect Laryngoscope Φ 20

NYD059.3
Indirect Laryngoscope Φ 18

NYD059.4
Indirect Laryngoscope Φ 16

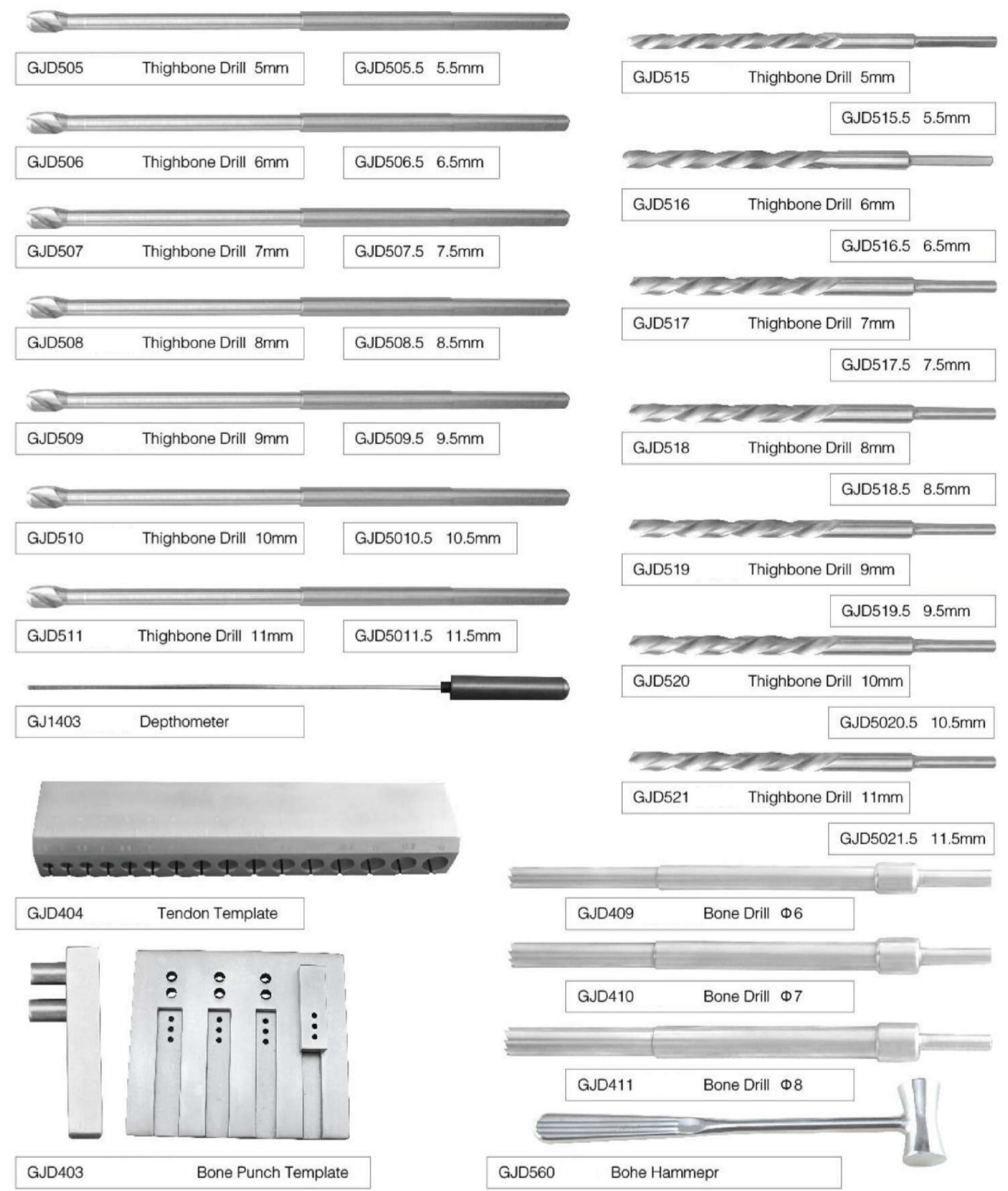
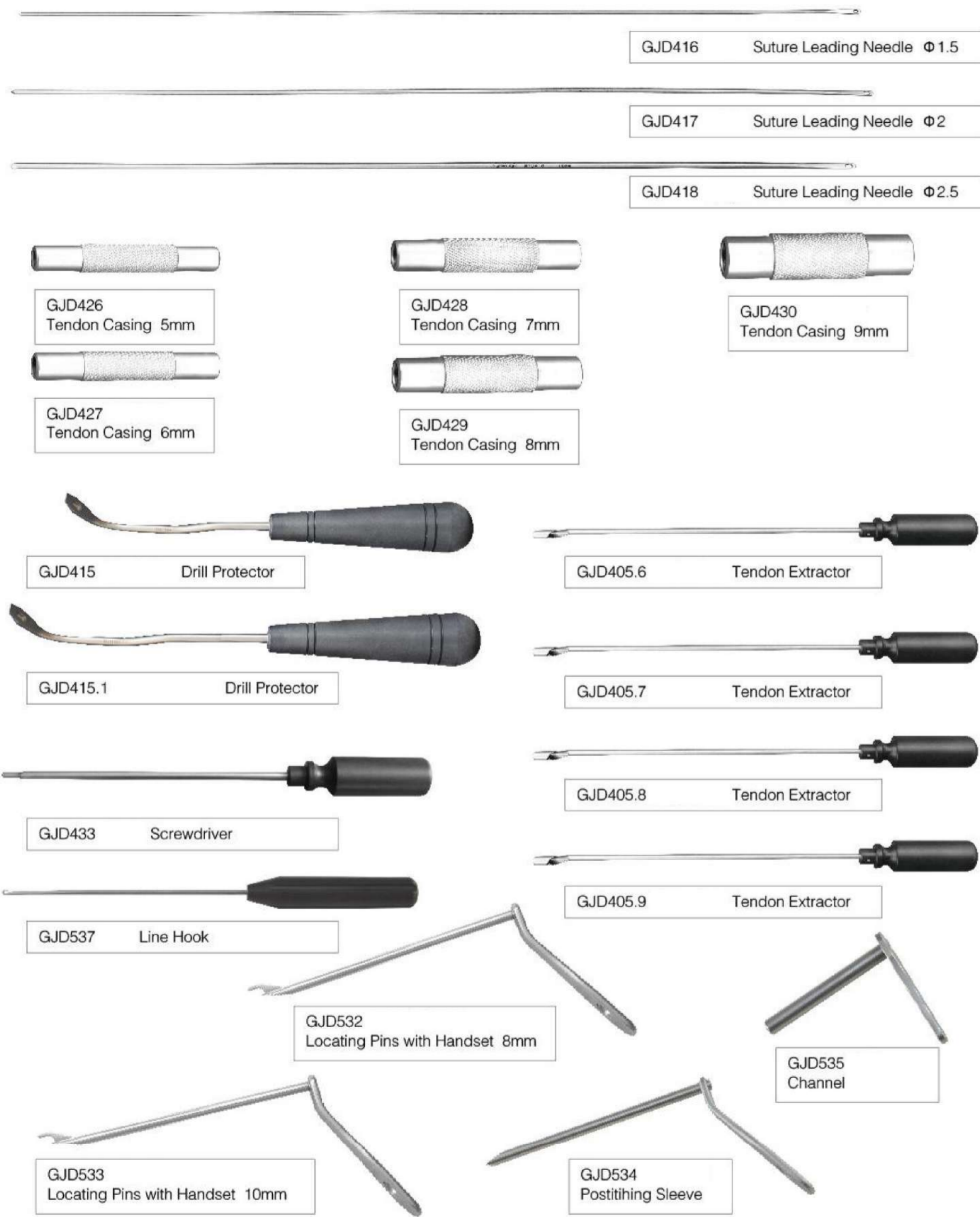

ZJ011 TOM $\Phi 3 \times 170\text{mm}$



ZJ012 TOM $\Phi 3 \times 170\text{mm}$



ZJ013 TOM $\Phi 3 \times 170\text{mm}$



ZJ014 $\Phi 2.4 \times 330\text{mm}$



ZJ015 $\Phi 2.4 \times 330\text{mm}$



ZJ016 $\Phi 2.4 \times 330\text{mm}$



ZJ017 $\Phi 1.5 \times 450\text{mm}$



ZJ018 $\Phi 0.8 \times 450\text{mm}$



ZJ019



- ZJ020 $\Phi 7.5 \times 160\text{mm}$ (45°)
- ZJ021 $\Phi 7.5 \times 165\text{mm}$ (70°)
- ZJ022 $\Phi 7.5 \times 170\text{mm}$ (120°)
- ZJ023 $\Phi 7.5 \times 180\text{mm}$ (70°)
- ZJ024 $\Phi 7.5 \times 120\text{mm}$ (30°)
- ZJ025 $\Phi 7.5 \times 120\text{mm}$ (45°)
- ZJ026 $\Phi 7.5 \times 120\text{mm}$ (70°)

ZJ027 $\Phi 6.3 \times 190\text{mm}$



ZJ028 $\Phi 3 \times 200\text{mm}$



ZJ029 $\Phi 4 \times 300\text{mm}$



ZJ030 $\Phi 3 \times 300\text{mm}$



ZJ031 $\Phi 4 \times 300\text{mm}$



ZJ032



ZJ033 $\Phi 1.2 \times 200\text{mm}$



ZJ034 $\Phi 1.2 \times 200\text{mm}$



ZJ035 $\Phi 3 \times 330\text{mm}$





Website : <http://Stronglapro.com>

Email : info@stronglapro.com

Phone : +923026198649

Address : Jourian Kalan Po Khas Tehsil
District Sialkot.

